

USER MANUAL



Nexa Modular GB2  
2-Wire Audio and  
Video Door Entry  
System  
Coded Panel



## INTRODUCTION

First and foremost we would like to thank you for purchasing this product.

Our commitment to achieving the satisfaction of customers like you is manifested through our ISO-9001 certification and the manufacture of products like the one you have just purchased.

Its advanced technology and strict quality control will ensure that customers and users enjoy the numerous features that this device offers. To get the most out of them and ensure proper operation from day one, we recommend that you read this instruction manual.

## CONTENTS

Introduction.....	2
Contents.....	2
Set-up warnings.....	2
Safety precautions.....	3
Characteristics.....	3
System operation.....	3
Description of the door panel.....	
Description of the Nexa Modular door panel.....	4
Description of the EL632/GB2A sound module.....	5
Description of the sound module DIP switch.....	6
Description of the configuration jumper.....	6
Description of the door panel lighting LEDs for "low light conditions".....	6
Description of the visual signals on the door panel.....	6
Description of the vocal synthesis (audible signals on the door panel).....	7
Selecting the sound module operating mode.....	7 - 8
Description of the TFT EL3422/GB2 screen module.....	9
Description of the N3401/GB2 and NX3401/GB2 proximity reader module.....	10
Description of the TK3401/GB2 proximity key kit.....	10
Description of the N3301/GB2 and NX3301/GB2 keypad access control module.....	11
Description of the EL3002H/GB2 auditory accessibility module.....	12
Description of the EL3002 illumination module.....	13
Installation of the door panel.....	
Preparing the cable entry.....	14
Fitting the embedding box.....	14
Mounting the electronic modules.....	14
Fastening the frame to the embedding box.....	15
Connections between the sound, TFT and access control modules.....	15
Closing the door panel.....	16
Installation of the power supply.....	16
Installation of the lock release.....	17
Operation of the door panel.....	17
Programming of the door panel.....	
Entering and exiting programming mode/Programming structure and sequence.....	18
Programming fields.....	19-25
Programming fields summary.....	26
Managing proximity keys.....	27-29
Managing the apartment list.....	30-34
Wiring diagrams.....	35-39

## SET-UP WARNINGS

- Do not overtighten the screws on the power supply connector.
- **Always disconnect the power supply** before installing or making modifications to the devices.
- The fitting and handling of these devices must be carried out by **authorised personnel**.
- The wiring must run at least **40cm away from any other wiring**.
- Before connecting the device to the mains, check the connections between the door panel, power supply unit, distributors, camera interface, GSM interface, monitors, telephones and hands-free audio terminals.
- Use the Golmar **RAP-2150** cable (2x1mm<sup>2</sup>).
- Always follow the instructions contained in this manual.











## SAFETY PRECAUTIONS

- **Always disconnect the power supply** before installing or making modifications to the devices.
- The fitting and handling of these devices must be carried out by **authorised personnel**.
- The wiring must run at least **40 cm away from any other wiring**.
- On the power supply unit:
  - ⌚ Do not overtighten the screws on the connector.
  - ⌚ Install the power supply unit in a dry protected location free from the risk of dripping or splashing water.
  - ⌚ Avoid locations that are humid, dusty or near heat sources.
  - ⌚ Ensure that the air vents are free from obstruction so that air can circulate freely.
  - ⌚ To avoid damage, the power supply unit must be firmly secured in place.
  - ⌚ To prevent electric shock, do not remove the cover or handle the wiring connected to the terminals.

## CHARACTERISTICS

- Audio and video door entry system with simplified wiring (non-polarised 2-wire bus).
- Up to 4 access panels (DP-GB2A distributor required for more than one access panel) per installation.
- Up to 23 monitors and apartments with a Vesta2 monitor per installation. (Mixed installation with telephones max. 23 elements).
- Up to 18 monitors and apartments with a Vesta7 monitor per installation. (Mixed installation with telephones max. 18 elements).
- Up to 32 telephones and apartments with T562 telephone per installation (audio door entry system installation 'audio only').
- Up to 32 Nhea hands-free audio terminals and apartments per installation (audio door entry system installation 'audio only').
- Up to 4 monitors/telephones per apartment.
- Up to 4 monitors in parallel (installation without distributors) per installation.
- Up to 128 telephones (T562/TNhea) and apartments per installation (EL632/GB2A set to mode 2 or 6 'audio only', see p. 7).
- Up to 1 telephone per apartment (EL632/GB2A set to operating mode 2 or 6 'audio only', see page 7).
- Different operating modes configurable on the EL632/GB2A sound module.
- Call confirmation tone.
- Visual signals providing the door panel with auditory accessibility (indicating call process, communication, door open and channel busy).
- Audible signals providing the door panel with visual accessibility (indicating call in progress, missed call, door open, call finished and engaged).
- Door opening timeable between 1 and 99 seconds.
- 2 outputs for independently activated lock releases.
- Relay 1 output to activate the DC or AC lock releases actuated by relay.
- Relay 2 output to activate the DC or AC lock releases actuated by relay.
- Input for exterior door opening button (Relay 1 output).
- Input for exterior door opening button (Relay 2 output).
- Maximum distance between the power supply and the furthest door panel: 80m with a cross-section of 1mm<sup>2</sup>.
- Maximum distance between the power supply and the last distributor: 80m with a cross-section of 1mm<sup>2</sup>.
- Maximum distance between the power supply and last telephone (audio only installation without distributors): 80 m with a cross-section of 1mm<sup>2</sup>.
- Maximum distance between the distributor and monitor/telephone (mixed installation): 40m with a cross-section of 1mm<sup>2</sup>.

## SYSTEM OPERATION

- To make a call, the visitor must select the apartment list or enter the apartment code; an audible sound indicates that the call is being made and LED  will illuminate. If vocal synthesis is enabled, a 'Call is in progress' message appears indicating that a call is being made. At this moment the apartment's monitor receives the call. To cancel the call, press the bell button or C.
- In systems with several access doors, the other door panel(s) will be automatically disconnected. If another visitor tries to call, a number of telephone tones will be heard to indicate that the system is busy and LED  will illuminate. If vocal synthesis is activated, the message 'System is busy, try later' will be indicated on the door panel.
- The call lasts for 40 seconds and, when received, the image appears on the master monitor without the visitor knowing. To view the image on a slave monitor, this function needs to have been activated on the monitor. If the call is not answered within 40 seconds, LED  will turn off and the channel will be freed.
- To establish communication, press button  on any monitor (or pick up the handset of any telephone) in the apartment and LED  on the door panel will illuminate. If the door panel has an EL3002H/GB2 module with icon  displayed on the front, the LED of the EL3002H/GB2 module will illuminate. Make sure that the hearing aid is 15-25 cm away from the door panel to ensure maximum audio quality during communication with the apartment.
- Communication will last for one and a half minutes or until button  on the monitor is pressed again (or the handset of the telephone is replaced). When communication has finished, LEDs  and  will turn off and the channel will be freed. If vocal synthesis is activated, a 'Communication is finished' message will indicate that the call is over.
- To open the door, press button  during the call or communication processes: one press will activate the lock release for five seconds and LED  will also turn on for five seconds. If vocal synthesis is enabled, a 'Door Opened!' message will be indicated on the door panel.
- For a description of the functioning and setup of the monitor/telephone, see the monitor's user manual.

DESCRIPTION OF THE DOOR PANEL

**Description of the Nexa modular door panel:**

Door panel component assembly drawing.

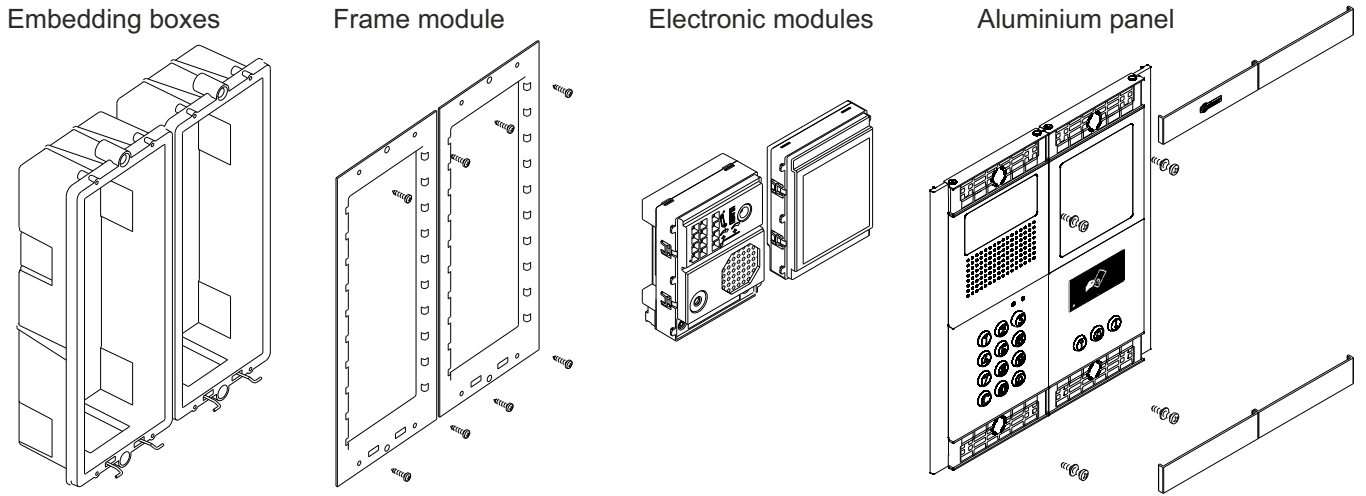

Description of the door panel.

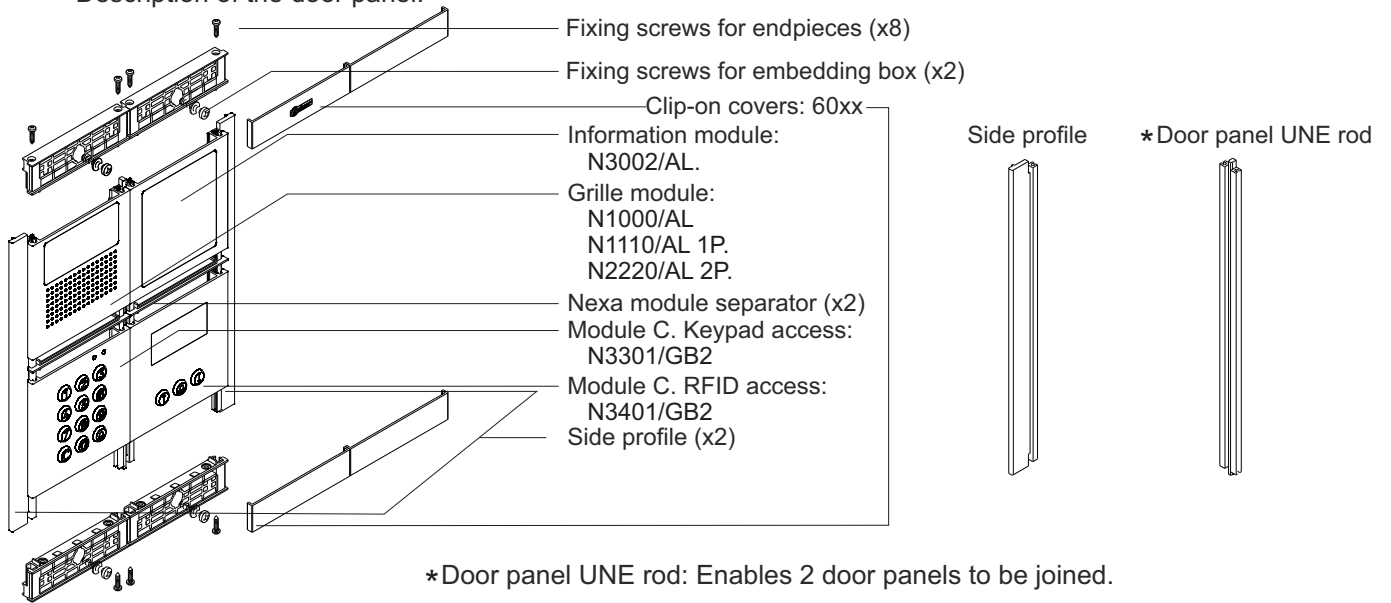

\*Door panel UNE rod: Enables 2 door panels to be joined.

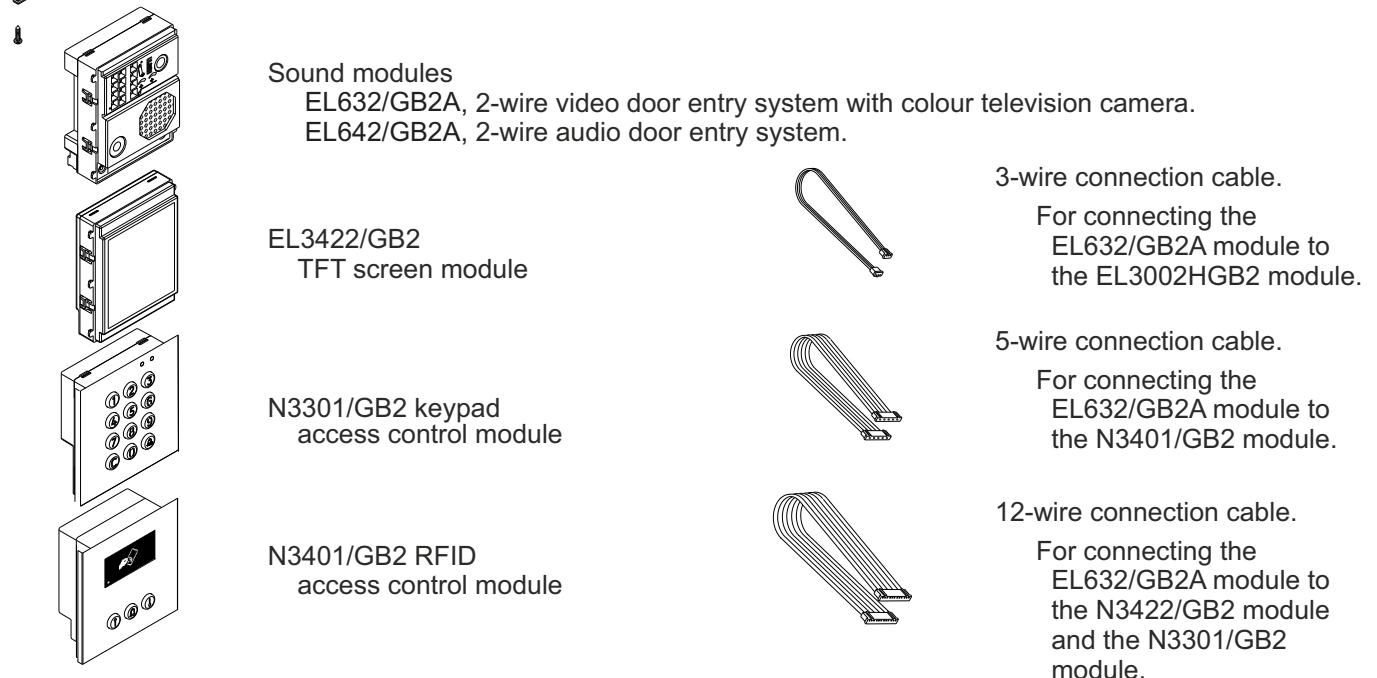

DESCRIPTION OF THE SOUND MODULE

**Description of the EL632/GB2A sound module:**

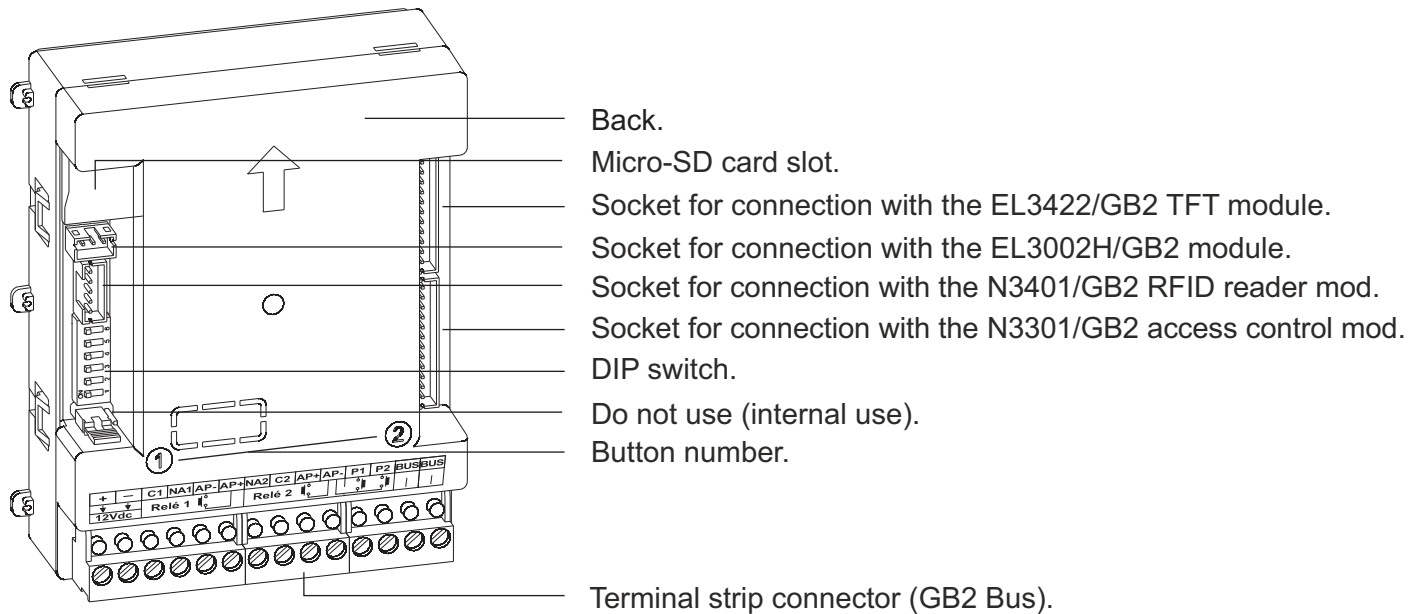
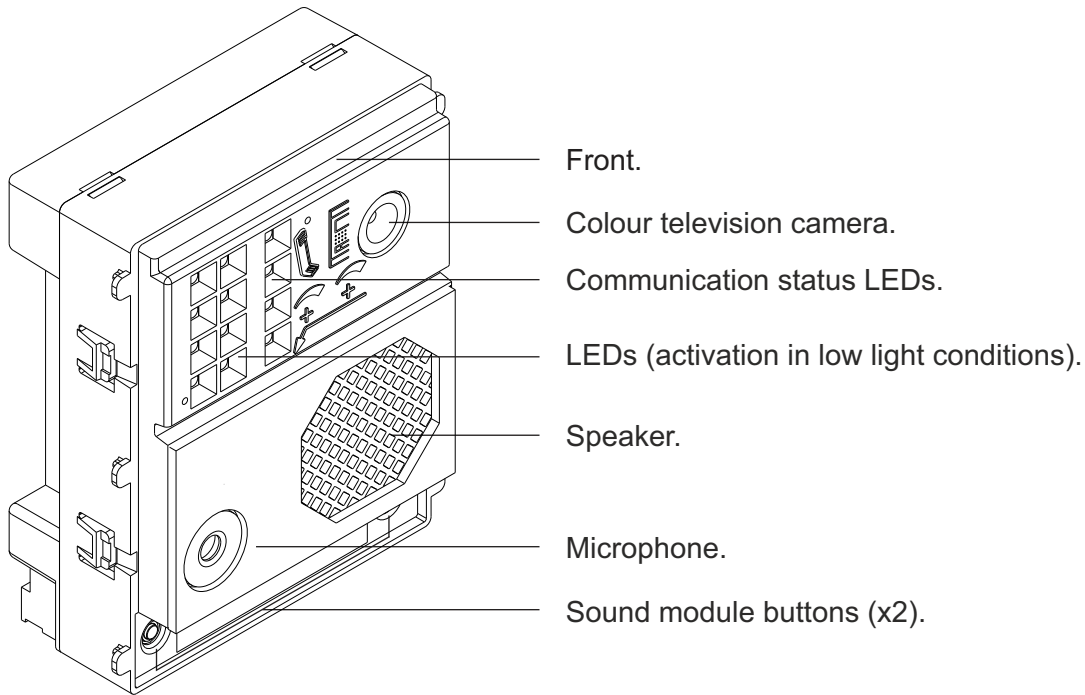

**Connection terminals:**

- +, - : Positive, negative (12Vdc output for Golmar DC electric lock).
- C1 : Contact 'C' for electric lock (Relay 1).
- NA1 : Contact 'NO' for electric lock (Relay 1).
- AP -, AP+ : Input for exterior door opening button (Relay 1).
- NA2 : Contact 'NO' for electric lock (Relay 2).
- C2 : Contact 'C' for electric lock (Relay 2).
- AP+, AP- : Input for exterior door opening button (Relay 2).
- P1 : Input for exterior call button (button 1).
- P2 : Input for exterior call button (button 2).
- BUS : Connection BUS (non-polarised).
- BUS : Connection BUS (non-polarised).

**Note:** See wiring diagrams for connections (pp. 35-39).





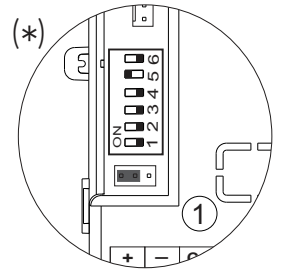

**DESCRIPTION OF THE SOUND MODULE**

**Description of the sound module DIP switch:**

The DIP switch is located on the left side of the back of the module.



- (\*)  Door panel address:  
DIP switches: 1 and 2 OFF (address 1), 1 ON and 2 OFF (address 2), 1 OFF and 2 ON (address 3), 1 and 2 ON (address 4).
- (\*)  Leave in the OFF position for door panels with double button and set to ON for door panels with single button.
- (\*)  Leave in the OFF position for use with door panels in houses and set to ON for use in apartment buildings.
- (\*)  Leave in the ON position to set the door opening time using the configuration menu. Set to OFF to set the door opening time to 1 second.
- (\*)  Set to ON to configure: (see pp. 7-8)  
Sound module operating mode. Leave in the OFF position once configuration is complete.

(\*) **Factory setting.**

**Description of the configuration jumper:**

**Important:** Do not change the factory default position of the configuration jumper.

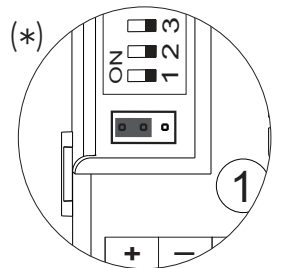

(\*) **Factory setting.**









**Description of the door panel lighting LEDs for low light conditions:**

The door panel lighting LEDs will turn on during a call if the door panel lighting at that moment is low. This enables the user to view the person who has called from the apartment monitor.



**Description of the visual signals on the door panel:**

Visual signals on the door panel, indicating:

- While calling: LED  will illuminate during in call and in communication times.
- During communication: LED  will illuminate during the communication process.
- During door release: LED  will illuminate during door release.
- End of communication: LEDs  and  will turn off.
- Calling at one door panel while another door panel is communicating (if there is more than one door panel): LED  will illuminate for 3 seconds.
- While calling and the monitor is in 'Do not disturb' mode: LED  will illuminate for 4 seconds.
- While calling (apartment with no monitor or telephone): LED  will illuminate for 4 seconds.

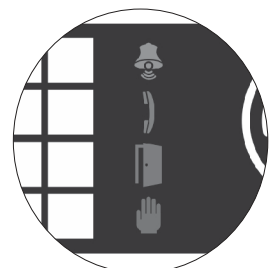

**DESCRIPTION OF THE SOUND MODULE**

**Description of the vocal synthesis (audible signals on the door panel):**

Audible signals on the door panel.

If vocal synthesis is enabled on the sound module (see page 19 and 21 for configuration), the following voice messages can be heard on the door panel:

- While calling: 'Call is in progress'.
- During door release: 'Door Opened!'.
- End of communication: 'Communication is finished'.
- Calling at one door panel while another door panel is communicating (if there is more than one door panel): 'System is busy, try later'.
- While calling and the monitor is in 'Do not disturb' mode: 'Call is in progress'.
- While calling (apartment with no monitor or telephone): 'Resident Unavailable'.

**Selecting the sound module operating mode:**

To change the operating mode of the sound module, follow these steps:

- Disconnect the door panel's power supply.
- Set DIP 6 on the sound module (see page 6) to OFF.
- Reconnect the door panel's power supply.
- Set DIP 6 to ON.
- Press and hold down button P1 on the sound module for 6 seconds (until the confirmation tones end).
- Then continue pressing to change the operating mode indicated by the visual alert LEDs of the door panel 'carousel mode' (see the following operating mode selection table). Once the required operating mode is selected, stop pressing button P1.
- Finally, set DIP 6 to OFF. A confirmation tone will be heard and the visual alert LEDs of the door panel will turn off.

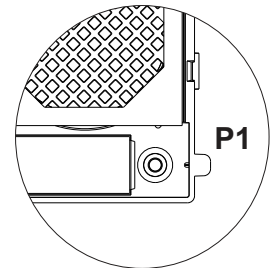

**Operating modes**

Mode	Dip4	Function mode	Door panel	Installation	LED	LED	LED	LED
(1) (*) House	OFF	(*) 1	Buttons	Video panel	ON	OFF	OFF	OFF
Building (Up to 32 monitors/telephones)	ON	(*) 1	Buttons	Video panel/ Audio panel	ON	OFF	OFF	OFF
Building 'tel. only' (Up to 128 telephones)	ON	2	Buttons	Audio panel	OFF	ON	OFF	OFF
(2) Building 'router' (Up to 128 monitors/telephones)	ON	3	Buttons	Video panel (Inst. with risers)	ON	ON	OFF	OFF
(2) Building 'gateway' (Up to 128 monitors/telephones)	ON	4	Buttons	Video panel (Gen. panel inst.)	OFF	OFF	ON	OFF
Building (Up to 32 monitors/telephones)	ON	5	Coded	Video panel/ Audio panel	ON	OFF	ON	OFF
Building 'tel. only' (Up to 128 telephones)	ON	6	Coded	Audio panel	OFF	ON	ON	OFF
(2) Building 'router' (Up to 256 monitors/telephones)	ON	7	Coded	Video panel (Inst. with risers)	ON	ON	ON	OFF
(2) Building 'gateway' (Up to 256 monitors/telephones)	ON	8	Coded	Video panel (Gen. panel inst.)	OFF	OFF	OFF	ON
Mode 9 to 12 (no function)					-----	-----	-----	-----

(1) House mode. See the manual enclosed with the corresponding GB2 house kit.

(2) Building mode 'router'/'gateway'. See the manual enclosed with the RD-GB2/A module.

(\*) Sound module configured with **default setting**: house mode and operating mode 1.

---

## DESCRIPTION OF THE SOUND MODULE

---

### **Selecting the sound module operating mode:**

**Continued from previous page**

**Building mode:** Set DIP 4 on the sound module to ON (see page 6).

- Up to 23 monitors and apartments with a Vesta2 monitor per installation.  
(Mixed installations with telephones up to 23 elements).
- Up to 18 monitors and apartments with a Vesta7 monitor per installation.  
(Mixed installations with telephones up to 18 elements).
- Up to 32 telephones and apartments with T562/Nhea telephones per installation.  
(Audio door entry system installation audio only).

**Building mode 'telephones only' (audio panel):** Up to 128 telephones/apartments.  
Set DIP 4 on the sound module to ON (see page 6).

**Building mode 'router':** Set DIP 4 on the sound module to ON (see page 6).

- Up to 23 monitors and apartments with a Vesta2 monitor per riser (RD-GB2/A module(s) required).  
(Mixed installations with telephones up to 23 elements).
- Up to 18 monitors and apartments with a Vesta7 monitor per riser (RD-GB2/A module(s) required).  
(Mixed installations with telephones up to 18 elements).
- Up to 32 telephones and apartments with T562/Nhea telephones per riser (RD-GB2/A module(s) required).  
(Audio door entry system installation audio only).

**Building mode 'gateway':** Set DIP 4 on the sound module to ON (see page 6).

- Up to 23 monitors and apartments with a Vesta2 monitor per interior panel (RD-GB2/A module(s) required).  
(Mixed installations with telephones up to 23 elements).
- Up to 18 monitors and apartments with a Vesta7 monitor per interior panel (RD-GB2/A module(s) required).  
(Mixed installations with telephones up to 18 elements).
- Up to 32 telephones and apartments with T562/Nhea telephones per interior panel (RD-GB2/A module(s) required).  
(Audio door entry system installation audio only).



DESCRIPTION OF THE TFT SCREEN MODULE

Description of the EL3422/GB2 TFT screen module:

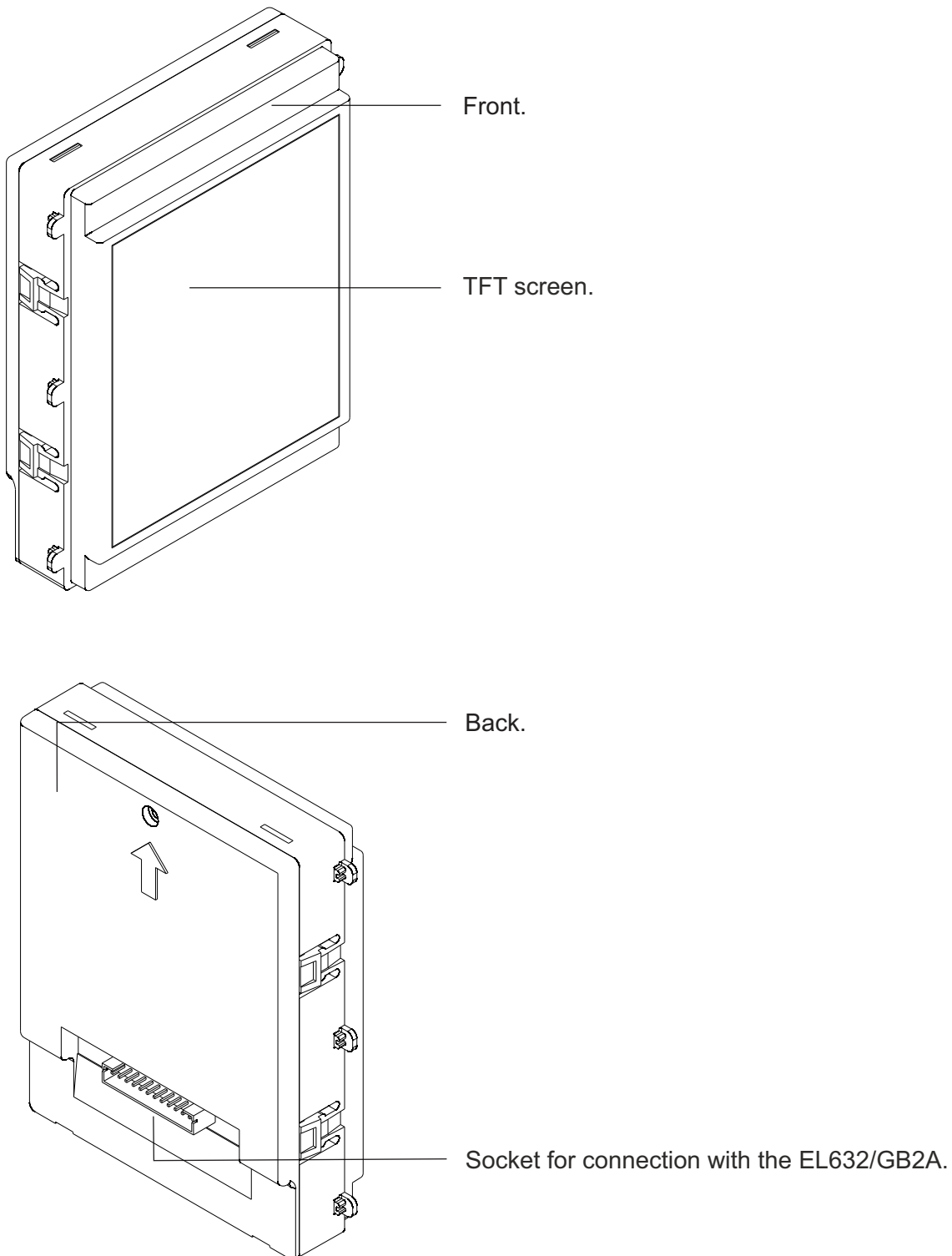

**Note:** See its connections (page 15).

DESCRIPTION OF THE PROXIMITY ACCESS CONTROL MODULE

Description of proximity reader modules N3401/GB2 and NX3401/GB2:

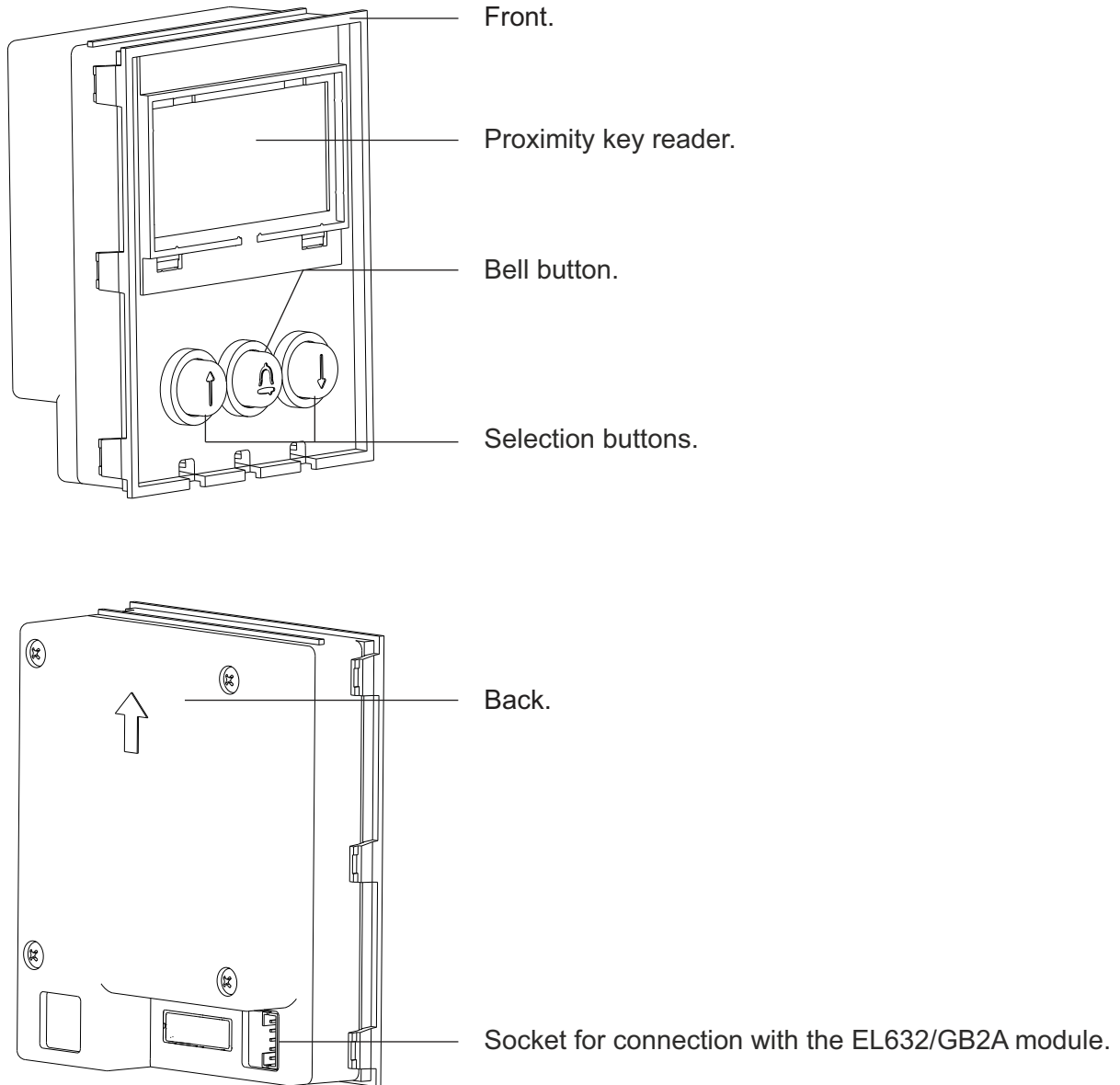

**Note:** See its connections (page 15).

Description of the TK3401/GB2 proximity key kit:

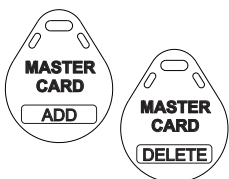

Management keys for adding/deleting residents keys using the N3401/GB2 module.

**MASTER CARD ADD:** Key for adding residents proximity keys.  
**MASTER CARD DELETE:** Key for deleting residents proximity keys.



TAGKEY residents access keys (Code 20740427).

**Note:** To add/delete proximity keys, follow the instructions on pp. 27-29.

DESCRIPTION OF THE KEYPAD ACCESS CONTROL MODULE

Description of the N3301/GB2 and NX3301/GB2 keypad access control module

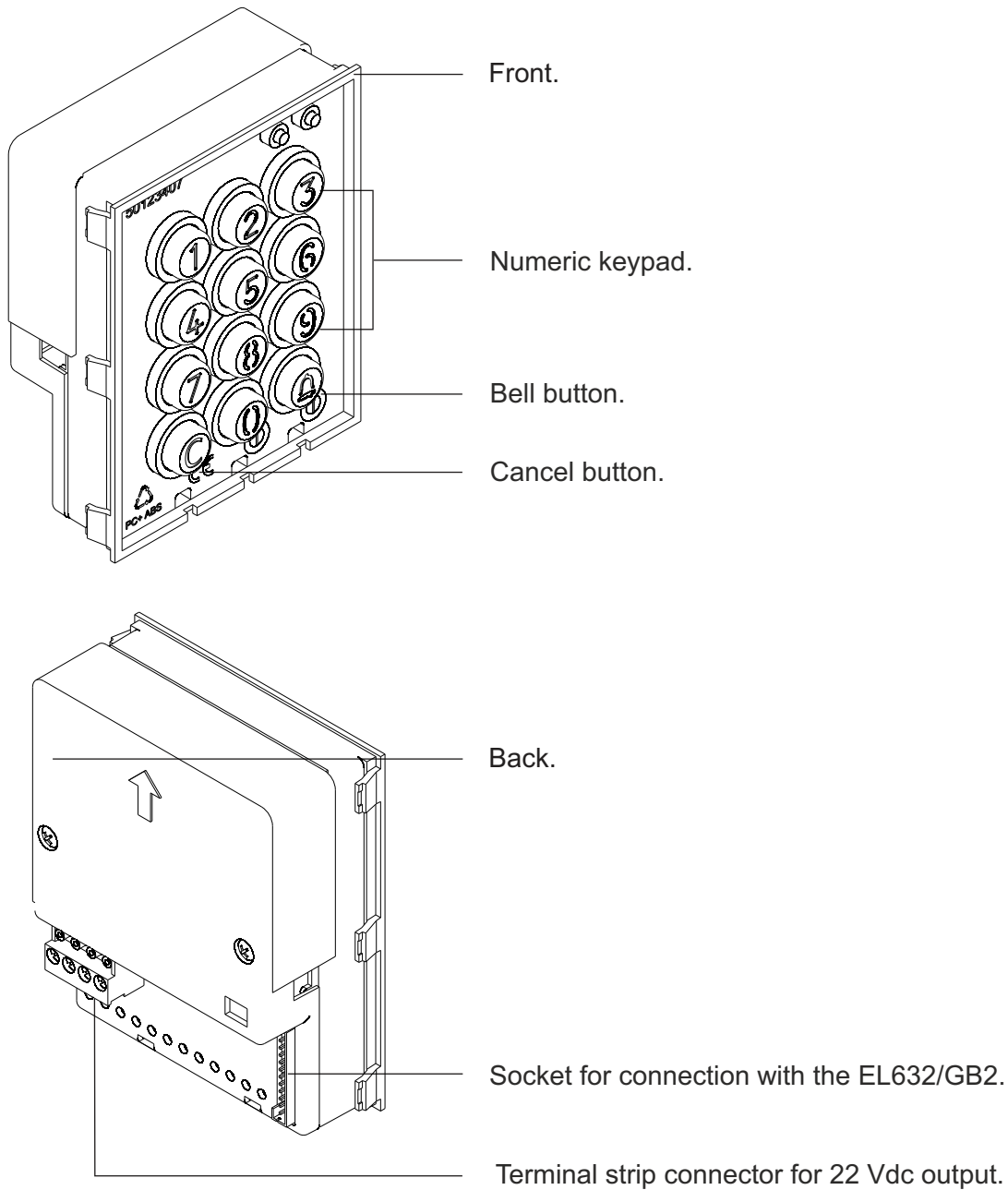

Connection terminals:

+ - : Positive, negative (22 Vdc output maximum 100 mA)

**IMPORTANT:**

N3301/GB2 and NX3301/GB2 modules are not compatible with the connections of EL610D button modules.

**Note:**

See the connections of the N3301/GB2 and NX3301/GB2 modules on page 15.

## DESCRIPTION OF THE AUDITORY ACCESSIBILITY MODULE

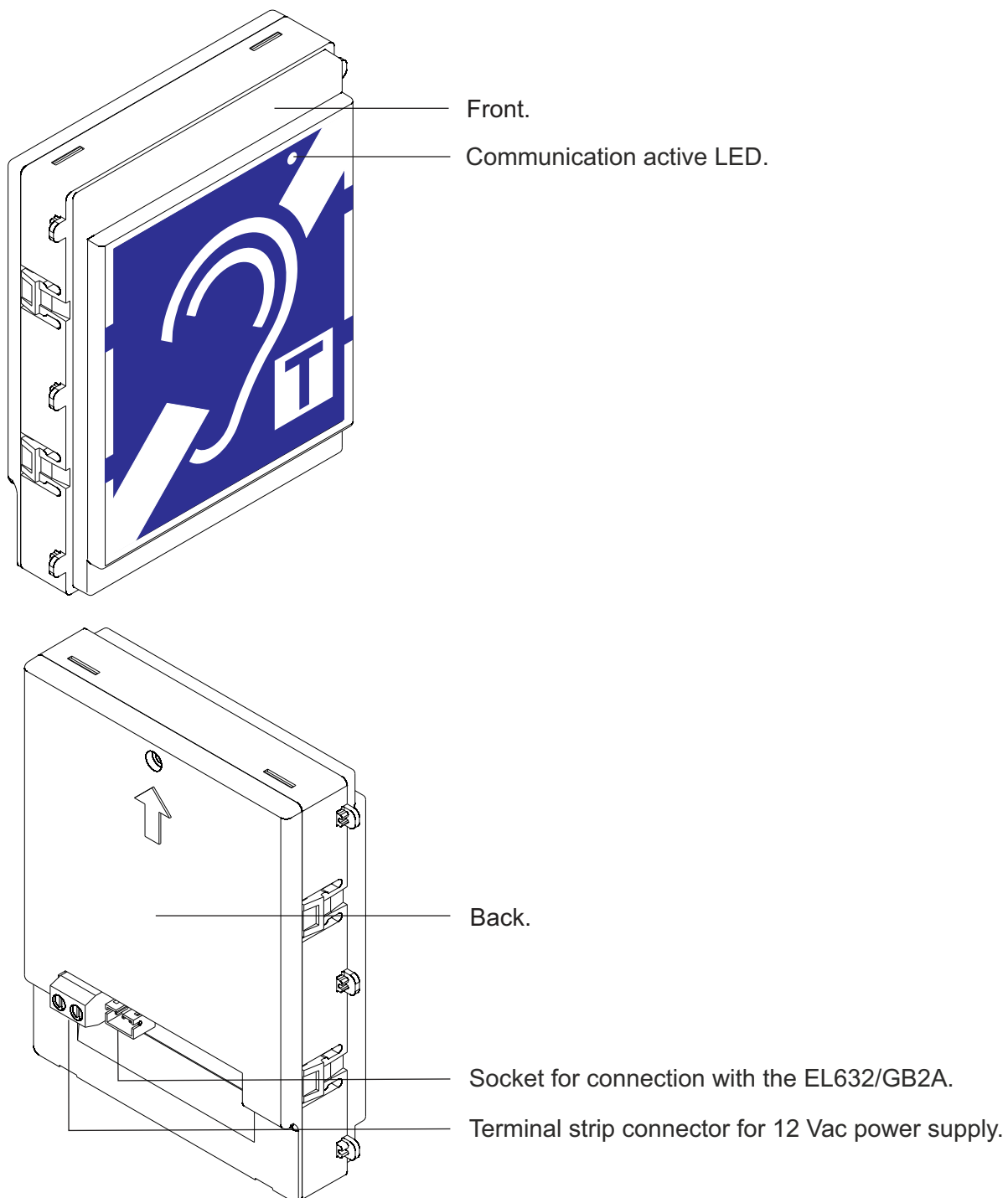
Description of the EL3002H/GB2 auditory accessibility module:Connection terminals:

~ ~ : 12 Vac power input (Only required if EL610D modules exist)

**Note:** See its connections (page 15).

DESCRIPTION OF THE ILLUMINATION MODULE

Description of the EL3002 illumination module

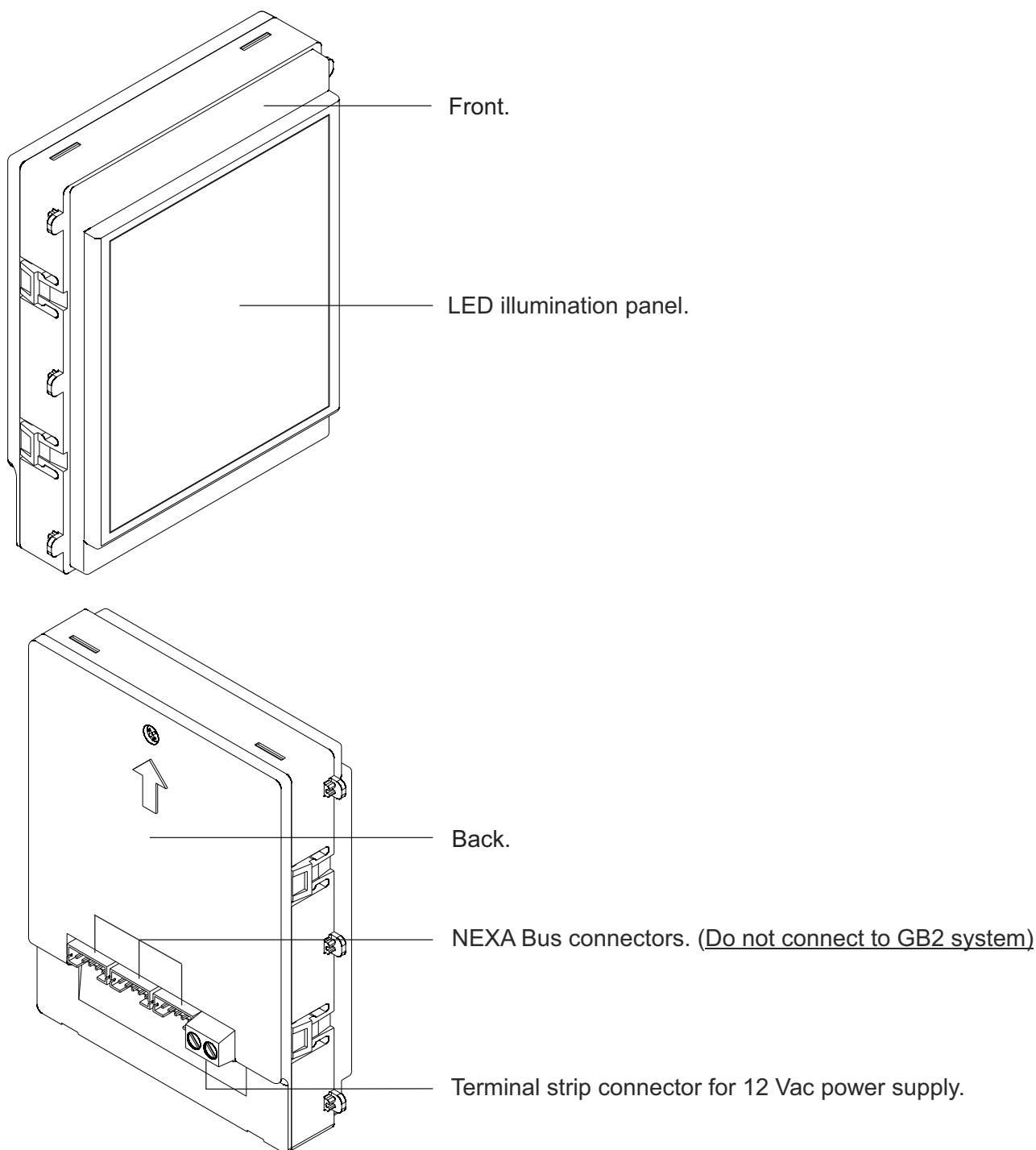

Connection terminals:

?? : 12 Vac power input

**Note:** See its connections (page 15).

**INSTALLATION OF THE DOOR PANEL**

**Preparing the cable entry:**

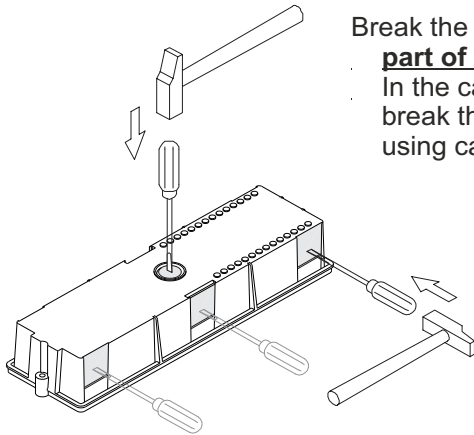

Break the flange to allow entry of cables through the bottom part of the embedding box.  
 In the case of door panels with more than one embedding box, break through the side holes and join the embedding boxes using cable grommets.

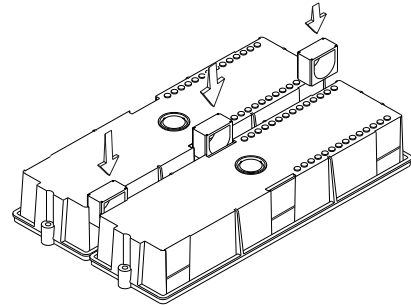

**Fitting the embedding box:**

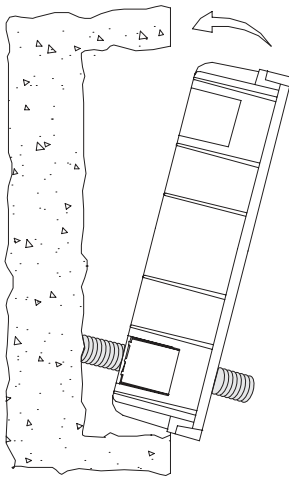

Pass the cable through the hole made in the embedding box. Embed the box and ensure that it is level and flush. Once the embedding box is positioned, remove the protective stickers from the door panel's fixing holes.

**Mounting the electronic modules:**

Insert the sound module into the top of the frame module.  
 Line up the clips on the sound module with the respective housings on the frame module and then press gently until correctly positioned.

If TFT module exists, repeat the above process, positioning it below the sound module, as shown in the drawing.

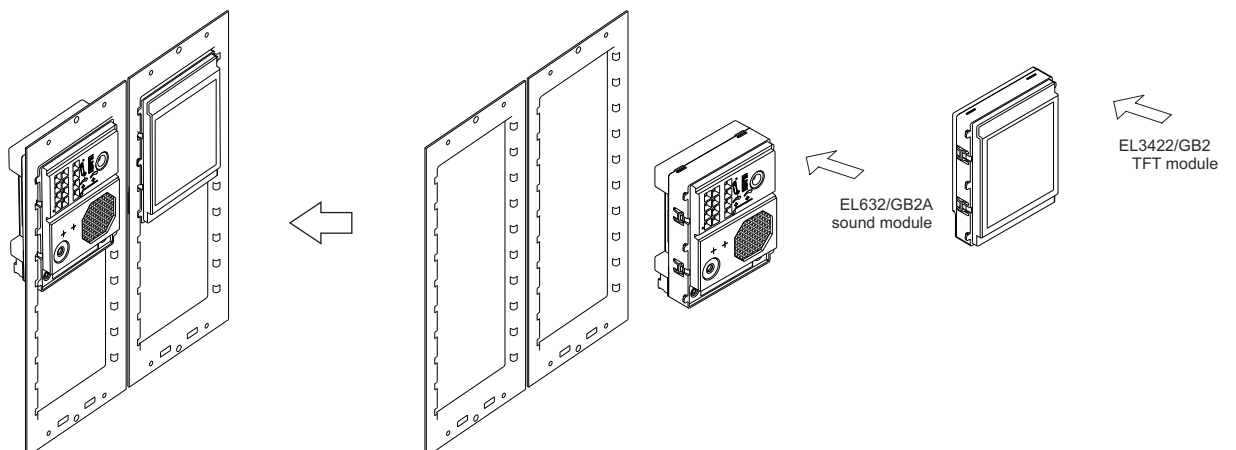



**INSTALLATION OF THE DOOR PANEL**

**Fastening the frame to the embedding box:**

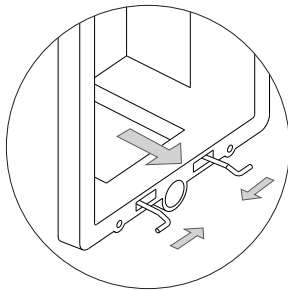

Insert the spring hinge which attaches to the product in the embedding box, as shown in the drawing.

To fasten the frame to the embedding box, insert the spring hinge into the housings provided for this purpose in the frame, as shown in the drawing.

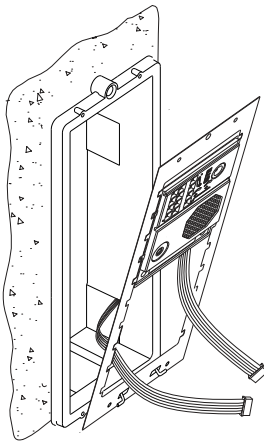
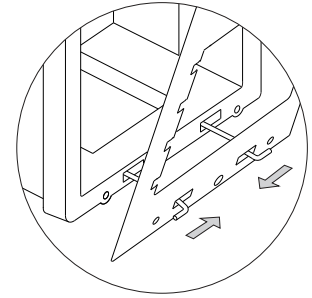

The frame can now be tilted horizontally to enable connection and setting of the sound module, TFT module and access control modules. Connect the sound module to the different modules as shown in the following section.

**Connections between the sound, TFT and access control modules:**

Once the wiring and configuration work is done, fix the frame to the embedding box using the screws supplied. Then place the access control modules into the frame in order to connect the connection cables between the sound module, access control modules and TFT as shown in the next section.

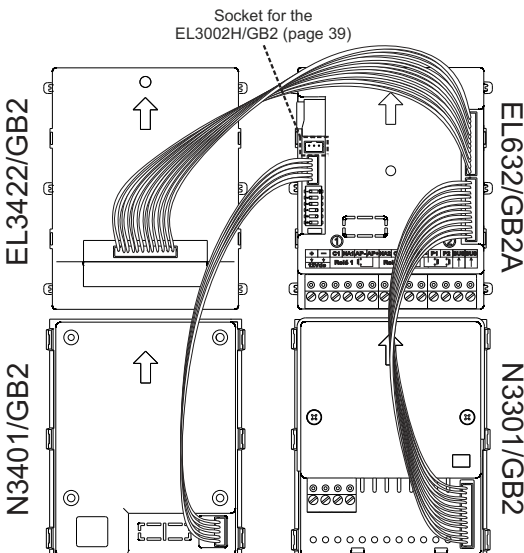
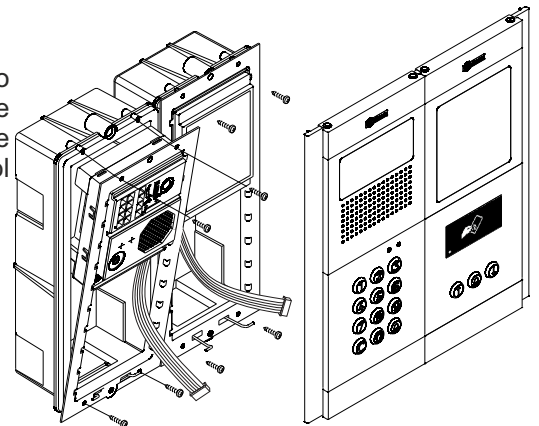

Plug one end of the connection cable attached to the EL3422/GB2 product into the 12-pin socket located on the top right of the sound module and the other end into the socket located in the centre of the EL3422/GB2 module. Similarly, connect one end of the connection cable attached to the N3401/GB2 product to the 5-pin socket located in the left centre of the sound module and the other end to the socket located on the bottom right of the N3401/GB2 module. And connect one end of the connection cable attached to the N3301/GB2 product to the 12-pin socket located on the bottom right of the sound module and the other end to the socket located on the bottom right of the N3301/GB2 module.

**INSTALLATION OF THE DOOR PANEL**

***Closing the door panel:***

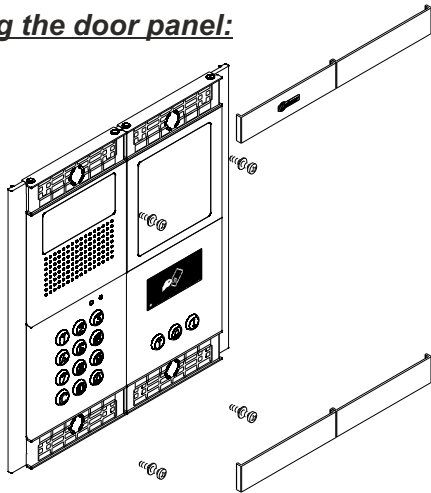

Fix the door panel to the embedding box using the screws supplied.

To complete the fitting of the panel, attach the clip-on covers by positioning one end and then applying slight pressure to the other end until they clip into place.

**INSTALLATION OF THE POWER SUPPLY UNIT**

***Installing the FA-GB2/A power supply unit:***

Install the power supply unit in a dry protected location free from the risk of dripping or splashing water. To prevent electric shock, do not remove the protective cover of the primary or handle the wiring. The fitting and handling of this device must be carried out by **authorised personnel** in the absence of electrical current. To avoid damage, the power supply unit must be firmly secured in place.

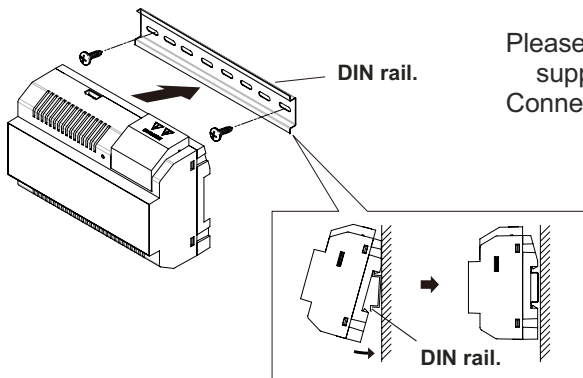

Please note that current regulations stipulate that the power supply must be protected by a circuit breaker. Connect the FA-GB2/A power supply unit to the earth connection.

Mount the DIN rail to the wall with the plugs and screws supplied. Then attach the power supply by applying slight pressure.

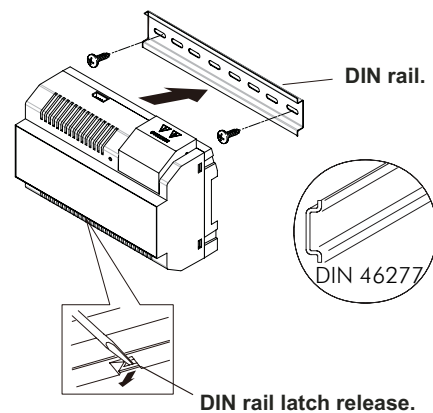

The power supply can be installed on a DIN 46277 rail. To remove the power supply unit from the DIN rail, use a flat screwdriver to lever it off, as shown in the drawing. The FA-GB2/A model requires 8 elements on the rail.

**IMPORTANT:** the maximum number of units that can be connected to an FA-GB2/A power supply is 23 VESTA 2 or 18 VESTA7 monitors.

**Replace the protective cover once the input terminals have been wired.**

## INSTALLATION OF THE LOCK RELEASE

### Installing the lock release:

If the lock release is to be fitted to a metal door, use a Ø3.5mm drill bit and thread the hole made. For wooden doors, use a Ø3mm drill bit.

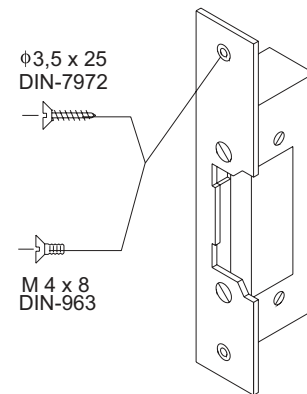

### **IMPORTANT:**

- The lock release must be 12V DC or AC (Golmar).  
(See page 38 for a.c. lock release and page 35-37 for d.c. lock release).
- The sound module is supplied with two varistors. If connecting an AC lock release to one of the outputs, fit the varistor supplied directly to the lock release terminals to ensure the device functions correctly.

## DOOR PANEL OPERATION

### Description of door panel operation:

Door panel in standby mode.

With the door panel in standby mode, the following operations can be performed:

**Activation of external buttons:** Enables activation of the outputs of Relay 1 or Relay 2 by means of the exterior AP buttons for Relay 1 and Relay 2.

### By keypad:

**Default administrator code:** 1234.

**Opening by means of the access code:** Enables activation of the output (Relay 1 or Relay 2) associated with the code. Press the bell button of the N3301/GB2 module, followed by the access code, and confirm with the bell button of the N3301/GB2 module.

**'bell (N3301/GB2)' + 'access code' + 'bell (N3301/GB2)'.**

**Administrator code:** Enables entry into the door panel's programming mode. Press the bell button of the N3301/GB2 module, followed by the administrator code, and confirm with the bell button of the N3301/GB2 module.

**'bell (N3301/GB2)' + 'administrator code' + 'bell (N3301/GB2)'.**

**Calls to monitors and telephones:** Enables calls to be made to monitors and/or telephones connected to the same installation. Press the monitor or telephone code followed by the bell button.

**'monitor/telephone code' + 'bell'.**

**Calls to monitors and telephones through the apartment list:** Enables calls to be made to monitors and/or telephones connected to the same installation. Search for the resident using the arrow keys and press bell to make the call.

**'Search resident using arrows button' + 'bell'.**

### By proximity:

**Opening by means of proximity key:** Enables activation of the Relay 1 output associated with the proximity key. Hold the RFID key near to the reader of the N3401/GB2 module.

**Managing proximity keys:** Enables the adding/deleting of proximity keys to be managed using the MASTER CARD keys included in the TK3401/GB2 kit. Use MASTER CARD ADD to add cards or MASTER CARD DELETE to delete them. It is also possible to Activate/Deactivate the proximity reader and delete all residents keys.

**PROGRAMMING THE DOOR PANEL**

**Programming mode entry and exit:**

To enter programming mode, press the bell button (N3301/GB2), followed by the administrator code '1234', and finally confirm by pressing the bell button (N3301/GB2) again.

'bell (N3301/GB2)' + 'administrator code' + 'bell (N3301/GB2)'.

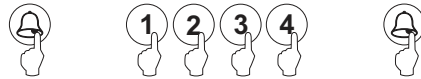

To exit programming mode, press the C button (cancel) once if it is in a programming field or twice if not. If no button is pressed within 10 seconds, it exits programming mode. Programming mode entry and exit is confirmed by the emitting of a long and short tone.

**Programming mode structure and sequence:**

Programming of the keypad functions is performed by entering the field or function code, followed by the bell button (N3301/GB2) and the field value.

Once in programming mode, the programming sequence is as follows:

Enter the code of the field to be programmed: this code is always 2 digits. To confirm, press the bell button (N3301/GB2) and the keypad will emit a long and then short tone indicating that the field to be programmed is correct or three short tones if the indicated programming field does not exist.

Enter the value of the field being programmed. Once the value has been entered, press the bell button (N3301/GB2) and the door panel will emit a long confirmation tone if the information entered is correct or three short tones if it is not correct.

Note: If no key is pressed within 10 seconds, it will be necessary to enter the programming code and select the programming field again.

Enter the code of the following field or press the C button (cancel) to exit programming mode.

If wrong information is entered or an access or administrator code is repeated, the door panel will emit three short tones to indicate that the information is incorrect. If the field code to be programmed was being entered, the programming code must be re-entered; if the field value was being entered, the field value being configured must be re-entered.

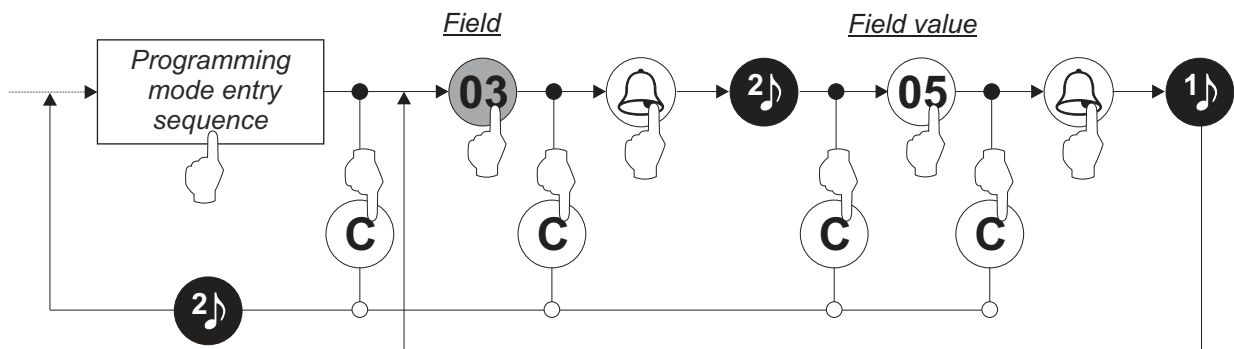

**PROGRAMMING THE DOOR PANEL**

**Programming fields:**

The module is pre-programmed with factory settings except for the activation codes, which are left empty for security reasons. For system operation tailored to the needs of the user, check the values set in all of the fields. The fields do not need to be programmed in numerical order.

Enter programming mode:

Step 1: Press the bell button (N3301/GB2), followed by the administrator code, and confirm with the bell button on the module (N3301/GB2).

**Bell (N3301/GB2) + administrator code + bell (N3301/GB2).**

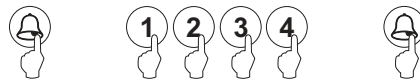

Step 2: Then press the field number:

**Field '01':** Sets the administrator code.

**Steps: Field + bell (N3301/GB2) + administrator code + bell (N3301/GB2).**



(Step 1)  Press '01' to select field '01'.

(Step 2)  Press the bell button (N3301/GB2) to finish programming the field.

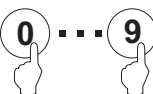
(Step 3)  Define the new administrator code using the numeric buttons from 0 to 9. The maximum length of the administrator code is 12 digits.  
The factory setting is 1234

(Step 4)  Press the bell button (N3301/GB2) to confirm the selection of the field.

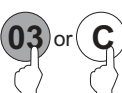
(Step 5)  Then press the number of the next field to configure or press the C button (cancel) to exit programming mode.

PROGRAMMING THE DOOR PANEL

**Programming fields:**





Continued from previous page

**Field '03':** Sets relay activation time.

Enables the setting of an activation time for Relay 1 and Relay 2 between 1 and 99 seconds.

**Steps: Field + bell (N3301/GB2) + activation time + bell (N3301/GB2).**



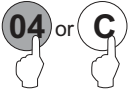



- (Step 1)  Press '03' to select field '03'.
- (Step 2)  Press the bell button (N3301/GB2) to confirm the selection of the field.
- (Step 3)  Define the activation time for the relays using the numeric buttons from 0 to 9. The time entered must have two digits.  
The factory setting is 01 seconds
- (Step 4)  Press the bell button (N3301/GB2) to finish programming the field.
- (Step 5)  Then press the number of the next field to configure or press the C button (cancel) to exit programming mode.

**Field '04':** Sets relay activation mode.

Enables the setting of an activation mode for Relay 1 and Relay 2 between 0 (normally open) or 1 (normally closed).

**Steps: Field + bell (N3301/GB2) + activation mode + bell (N3301/GB2).**

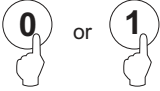

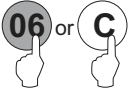
- (Step 1)  Press '04' to select field '04'.
- (Step 2)  Press the bell button (N3301/GB2) to confirm the selection of the field.
- (Step 3)  Define the activation mode for the relays using the numeric buttons 0 or 1.  
0: Normally open.  
1: Normally closed.  
The factory setting is 0
- (Step 4)  Press the bell button (N3301/GB2) to finish programming the field.
- (Step 5)  Then press the number of the next field to configure or press the C button (cancel) to exit programming mode.

**Continued overleaf**



**PROGRAMMING THE DOOR PANEL**

**Programming fields:**

Continued from previous page

**Field '06':** Resets the administrator code to the factory setting and clears all access codes.

Enables the resetting of the administrator code to factory setting 1234 and the clearing of all access codes.

**Steps: Field + bell (N3301/GB2) + administrator code + bell (N3301/GB2).**

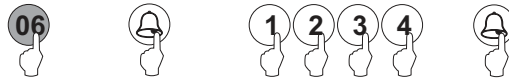

(Step 1)  Press '06' to select field '06'.

(Step 2)  Press the bell button (N3301/GB2) to confirm the selection of the field.

(Step 3)  Press default administrator code 1234.

(Step 4)  Press the bell button (N3301/GB2) to finish programming the field.

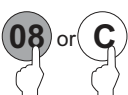
(Step 5)  Then press the number of the next field to configure or press the C button (cancel) to exit programming mode.

**Field '08':** Sets the vocal synthesis language.

Enables the setting of the language to be used for vocal synthesis messages by selecting between 0 and 5.

**Steps: Field + bell (N3301/GB2) + language selection + bell (N3301/GB2).**



(Step 1)  Press '08' to select field '08'.

(Step 2)  Press the bell button (N3301/GB2) to confirm the selection of the field.

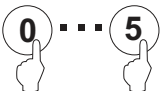
(Step 3)  Define the vocal synthesis language using the numeric buttons between 0 and 5.  
 0: No messages.  
 1: English.  
 2: Spanish.  
 3: French.  
 4: Dutch.  
 5: Portuguese.  
The factory setting is 0

(Step 4)  Press the bell button (N3301/GB2) to finish programming the field.

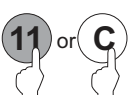
(Step 5)  Then press the number of the next field to configure or press the C button (cancel) to exit programming mode.

**Continued overleaf**

**PROGRAMMING THE DOOR PANEL**

**Programming fields:**





Continued from previous page

**Field '11':** Volume of the sound module speaker in communication.

Enables the setting of the speaker volume of the sound module in communication.

**Steps: Field + bell (N3301/GB2) + sound module volume level + bell (N3301/GB2).**

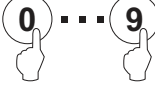

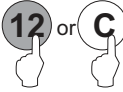



- (Step 1)  Press '11' to select field '11'
- (Step 2)  Press the bell button (N3301/GB2) to confirm the selection of the field.
- (Step 3)  Set the sound module speaker volume for when communication is established with a telephone or monitor using the numeric buttons from 0 to 9.  
The factory setting is 5.
- (Step 4)  Press the bell button (N3301/GB2) to finish programming the field.
- (Step 5)  Then press the number of the next field to configure or press the C button (cancel) to exit programming mode.

**Field '12':** Sets the vocal synthesis volume.

Enables the setting of the vocal synthesis volume by selecting between 0 and 9.

**Steps: Field + bell (N3301/GB2) + vocal synthesis volume + bell (N3301/GB2).**

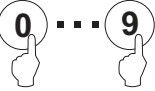

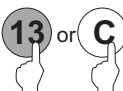
- (Step 1)  Press '12' to select field '12'.
- (Step 2)  Press the bell button (N3301/GB2) to confirm the selection of the field.
- (Step 3)  Define the vocal synthesis volume using the numeric buttons between 0 and 9, where 0 is the lowest volume and 9 is the highest.  
The factory setting is 5.
- (Step 4)  Press the bell button (N3301/GB2) to finish programming the field.
- (Step 5)  Then press the number of the next field to configure or press the C button (cancel) to exit programming mode.

**Continued overleaf**

**PROGRAMMING THE DOOR PANEL**

**Programming fields:**

Continued from previous page

**Field '13':** maximum intensity level of the illumination LEDs for the camera.

Indicates the intensity level of the illumination LEDs for the camera.

**Steps: Field + bell (N3301/GB2) + intensity + bell (N3301/GB2).**



(Step 1)  Press '13' to select field '13'.

(Step 2)  Press the bell button (N3301/GB2) to confirm the selection of the field.

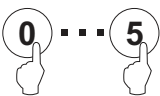
(Step 3)  Define the maximum intensity level of the illumination LEDs for the camera, using the numeric buttons 0 to 5, where 0 is the lowest level and 5 is the highest.  
The factory setting is 4.

(Step 4)  Press the bell button (N3301/GB2) to finish programming the field.

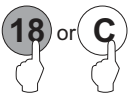
(Step 5)  Then press the number of the next field to configure or press the C button (cancel) to exit programming mode.

**Field '18':** Sets the temporary access code for Relay 1.

Enables the assignment of a temporary access code to activate Relay 1.

**Steps: Field + bell (N3301/GB2) + Relay 1 access code + bell (N3301/GB2).**



(Step 1)  Press '18' to select field '18'.

(Step 2)  Press the bell button (N3301/GB2) to confirm the selection of the field.

(Step 3)  Define the new temporary access code for Relay 1, using the numeric buttons 0 to 9. The maximum length of the access code is 12 digits.  
No factory setting has been defined

(Step 4)  Press the bell button (N3301/GB2) to finish programming the field.

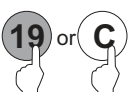
(Step 5)  Then press the number of the next field to configure or press the C button (cancel) to exit programming mode.

**Continued overleaf**

**PROGRAMMING THE DOOR PANEL**

**Programming fields:**





Continued from previous page

**Field '19':** Sets the temporary access code for Relay 2.

Enables the assignment of a temporary access code to activate Relay 2.

**Steps: Field + bell (N3301/GB2) + Relay 2 access code + bell (N3301/GB2).**

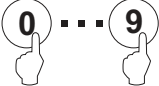





- (Step 1)  Press '19' to select field '19'.
- (Step 2)  Press the bell button (N3301/GB2) to confirm the selection of the field.
- (Step 3)  Define the new temporary access code for Relay 2, using the numeric buttons 0 to 9. The maximum length of the access code is 12 digits.  
No factory setting has been defined
- (Step 4)  Press the bell button (N3301/GB2) to finish programming the field.
- (Step 5)  Then press the number of the next field to configure or press the C button (cancel) to exit programming mode.

**Field '20-59':** Sets the access code for Relay 1.

Enables the storage of an access code to activate Relay 1. Up to 40 codes can be assigned for this relay.

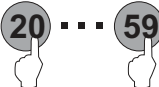
**Steps: Field + bell (N3301/GB2) + Relay 1 access code + bell (N3301/GB2).**

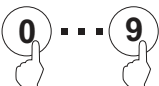

- (Step 1)  Press '20-59' to select field '20-59'.
- (Step 2)  Press the bell button (N3301/GB2) to confirm the selection of the field.
- (Step 3)  Define the new access code for Relay 1, using the numeric buttons 0 to 9. The maximum length of the access code is 12 digits.  
No factory setting has been defined
- (Step 4)  Press the bell button (N3301/GB2) to finish programming the field.
- (Step 5)  Then press the number of the next field to configure or press the C button (cancel) to exit programming mode.

**Continued overleaf**

PROGRAMMING THE DOOR PANEL

**Programming fields:**





Continued from previous page

**Field '60-99':** Sets the access code for Relay 2.

Enables the storage of an access code to activate Relay 2. Up to 40 codes can be assigned for this relay.

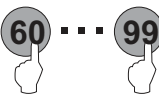
**Steps: Field + bell (N3301/GB2) + Relay 2 access code + bell (N3301/GB2).**

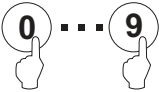

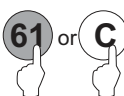
- (Step 1)  Press '60-99' to select field '60-99'.
- (Step 2)  Press the bell button (N3301/GB2) to confirm the selection of the field.
- (Step 3)  Define the new access code for Relay 2, using the numeric buttons 0 to 9. The maximum length of the access code is 12 digits.  
No factory setting has been defined
- (Step 4)  Press the bell button (N3301/GB2) to finish programming the field.
- (Step 5)  Then press the number of the next field to configure or press the C button (cancel) to exit programming mode.

## PROGRAMMING THE DOOR PANEL

### Programming fields:

The following table shows a summary of the programming fields available, the possible values that the programming fields can take by using the N3301/GB2 keypad and the default settings.

DESCRIPTION OF THE PROGRAMMING FIELD	PROGRAMMING FIELD	POSSIBLE VALUES	DEFAULT SETTINGS
Configure administrator code	01	0 ~ 9	1234
Configure relay activation time	03	01 ~ 99	01
Configure relay activation mode	04	0: Normally open 1: Normally closed	0: Normally open
Reset administrator code and access codes	06	Sequence (1,2,3,4)	-
Configure vocal synthesis language	08	0 ~ 5	0
Configure door panel in communication speaker volume	11	0 ~ 9	5
Configure vocal synthesis and beep volume	12	0 ~ 9	5
Configure camera illumination LED intensity level	13	0 ~ 5	4
Programme temporary access code/Relay1	18	0 ~ 9	-
Programme temporary access code/Relay2	19	0 ~ 9	-
Programme access code/Relay1	20-59	0 ~ 9	-
Programme access code/Relay2	60-99	0 ~ 9	-



**PROGRAMMING THE DOOR PANEL**

**Managing proximity keys:**

For resident proximity key access and management, the system must have an N3401/GB2 proximity access control module. TK3401/GB2 key kit not included.

**IMPORTANT:** It is necessary to initially activate the MASTER CARD ADD and MASTER CARD DELETE keys on the door panel to be managed before resident keys can be added/deleted.

**Activating MASTER CARD keys on the door panel:**

(Step 1)

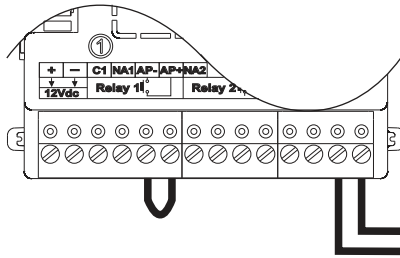

Cause a short circuit between the AP+ and AP- terminals of Relay 1 on the EL632/GB2A module.

(Step 2)

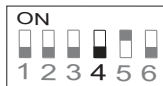

With the EL632/GB2A module connected and operating, set its DIP 4 to the OFF position. (At the end of programming, it must be returned to its initial position, for buildings/OFF for houses).

(Step 3) Using the DIP 4 located on the EL632/GB2A module, perform the following sequence:



At the end of the sequence, communication indicator and door open indicator will illuminate. You then have 10 seconds to perform the following step.

(Step 4) Hold the MASTER CARD ADD key near to the proximity reader located on the N3401/GB2 module and, once stored, communication indicator will turn off and the door panel will emit a confirmation tone.

Then hold the MASTER CARD DELETE key near to the proximity reader located on the N3401/GB2 module and, once stored, door open indicator will turn off and the door panel will emit a confirmation tone.

(Step 5) Set the DIP 4 on the EL632/GB2A module to the initial position and remove the short circuit between AP+ and AP-:

ON for buildings



OFF for houses

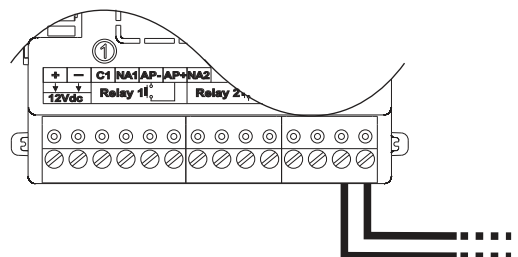

The same MASTER CARD keys can be added to as many door panels as necessary.

Proximity keys for residents can then be added/deleted as indicated in the following section.

## PROGRAMMING THE DOOR PANEL



---

### **Managing proximity keys:**



For resident proximity key access and management, the system must have an N3401/GB2 proximity access control module. TK3401/GB2 key kit not included.

**IMPORTANT:** It is necessary to initially activate the MASTER CARD ADD and MASTER CARD DELETE keys on the door panel to be managed before resident keys can be added/deleted as indicated in the following section.

### **Adding resident keys:**



- (Step 1) Hold the MASTER CARD ADD key near to the N3401/GB2 proximity reader, communication indicator  will illuminate and the door panel will emit a long and then short tone to indicate that it is in 'Add resident keys' mode.
- (Step 2) One by one, hold all of the keys to be added to the door panel near to the N3401/GB2 proximity reader. The door panel will emit a long tone each time it stores a proximity key or two short tones if the key has already been stored. A maximum of 320 access keys can be stored.
- (Step 3) Once all resident proximity keys have been added, complete the process by holding the MASTER CARD ADD key near to the N3401/GB2 proximity reader. Communication indicator  will turn off and the door panel will emit a short and then long tone to indicate that it has exited 'Add resident keys' mode.

### **Deleting resident keys:**

- (Step 1) Hold the MASTER CARD DELETE key near to the N3401/GB2 proximity reader, communication indicator  will illuminate and the door panel will emit a long and then short tone to indicate that it is in 'Delete resident keys' mode.
- (Step 2) One by one, hold all of the keys to be deleted from the door panel near to the N3401/GB2 proximity reader. The door panel will emit a long tone each time it deletes a proximity key or two short tones if the key does not exist on the door panel.
- (Step 3) Once all resident proximity keys have been deleted, complete the process by holding the MASTER CARD DELETE key near to the N3401/GB2 proximity reader. Door open indicator  will turn off and the door panel will emit a short and then long tone to indicate that it has exited 'Delete resident keys' mode.

### **Activating/deactivating the proximity reader:**

To activate or deactivate the proximity reader, the same procedure needs to be followed; if it was initially activated it will be deactivated and if it was initially deactivated after the process, the proximity reader will be activated.

- (Step 1) Hold the MASTER CARD ADD key near to the N3401/GB2 proximity reader, communication indicator  will illuminate and the door panel will emit a long and then short tone to indicate that it is in 'Add resident keys' mode.
- (Step 2) Then hold the MASTER CARD DELETE key near to the N3401/GB2 proximity reader, door open indicator  will illuminate and the door panel will emit a long and then short tone to indicate that it is in 'Activate/deactivate proximity reader' mode.
- (Step 3) Finally, hold the MASTER CARD DELETE key again to the N3401/GB2 proximity reader to activate/deactivate the proximity reader. The door panel will emit a long tone to indicate that it has been correctly modified.

**Continued overleaf**

---



## PROGRAMMING THE DOOR PANEL

---

### Managing proximity keys:

Continued from previous page

#### Deleting all resident proximity keys:

- (Step 1) Hold the MASTER CARD DELETE key near to the N3401/GB2 proximity reader, communication indicator  will illuminate and the door panel will emit a long and then short tone to indicate that it is in 'Delete resident keys' mode.
- (Step 2) Then hold the MASTER CARD ADD key near to the N3401/GB2 proximity reader, communication indicator  will illuminate and the door panel will emit a long and then short tone to indicate that it is in 'Delete all proximity keys' mode.
- (Step 3) Finally, hold the MASTER CARD ADD key again to the N3401/GB2 proximity reader to confirm deletion of all resident keys from the door panel. During the deletion process, the communication and door open indicators will blink. When complete, they will turn off.

**PROGRAMMING THE DOOR PANEL**

**Managing the apartment list:**

It is possible to display a contacts list on the EL3422/GB2 TFT screen module, selected using the selection keys on the N3401/GB2 module, and make a call by pressing the bell button on the same module.

The apartment list can be created using the 'Address Manager GB2' program, available for download from <https://doc.golmar.es>. By means of 'Address Manager GB2', it is also possible to reassign the terminal to which buttons 1 and 2 of the EL632/GB2A module and the buttons of the EL610D modules, if any, make the call.

**Generating a contacts list:**

- (Step 1) Press the 'New site' button to create a new project indicating the information related to the installation. This can be one building or several with similar characteristics, an area with a general panel and several buildings inside or even an entire block of buildings independent of each other. That way, the scope of the definition of the project can be decided by the designer of the project.

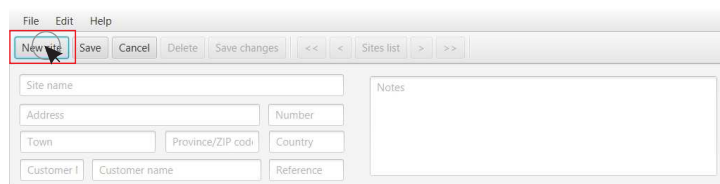

- (Step 2) Once the project information has been completed, click the 'Save' button located next to the 'New site' button.

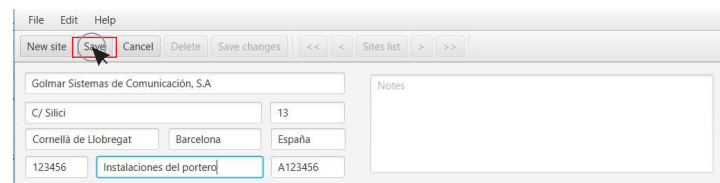

- (Step 3) Create a new door panel by clicking on the 'New entry panel' button located below the fields of the project header, and indicate all of the information concerning the door panel, as well as the door panel operating mode (see pp. 7 and 8) and the number of EL610D modules that it has (0 in the case of a coded panel).

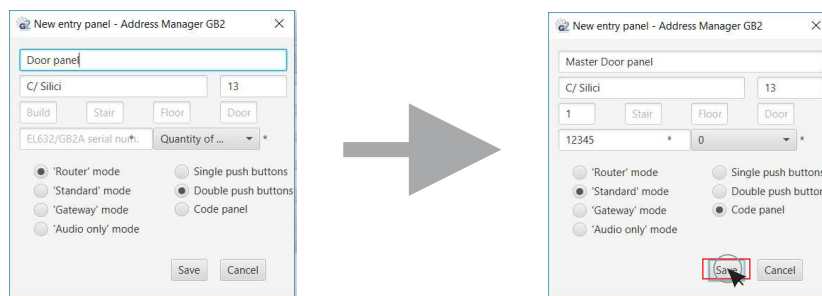

Once the configuration of the door panel is finished, press 'Save' to save the new information. It then appears in the project's door panel table and is accessible to create new contacts.

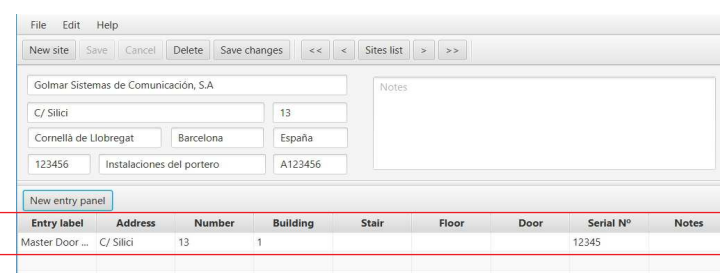

PROGRAMMING THE DOOR PANEL

**Managing the apartment list:**

Continued from previous page

(Paso 4) Then double-click on the list of the door panel to be modified to show its information, DIP switch configuration, operating mode and available modules.

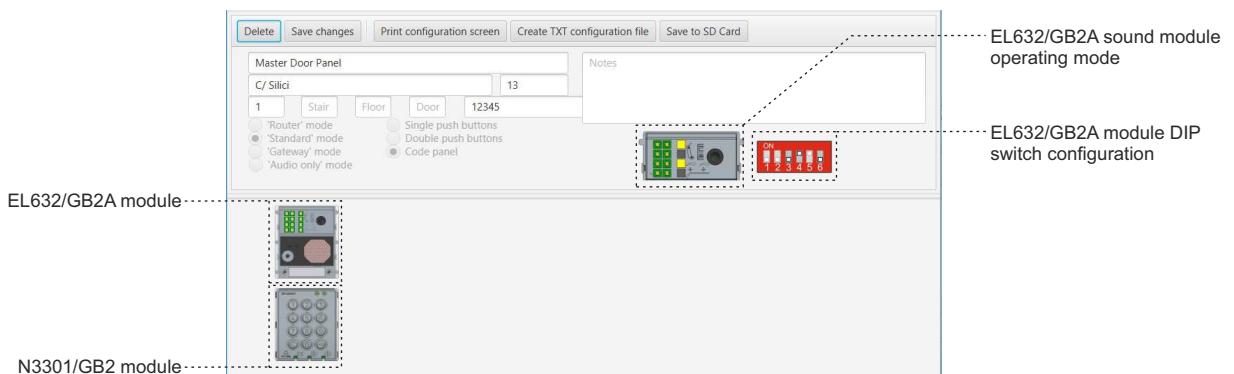
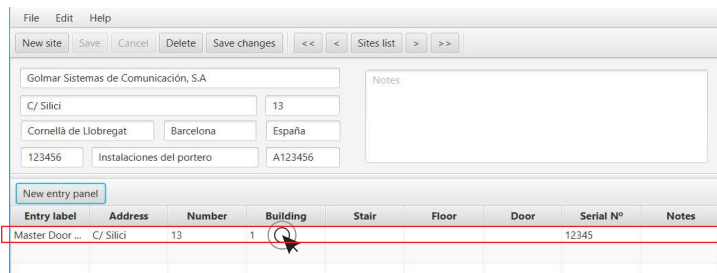

(Step 5) To assign a contact to the buttons of the EL632/GB2A module, click on the EL632/GB2A module icon. To add a contact to the list that does not depend on the buttons of the EL632/GB2A module, click on the N3301/GB2 module icon.

For each case, a different window will be displayed:

- In the first case, a window will be displayed where the buttons of the module are located:



- In the second case, a list of existing contacts will be displayed:



PROGRAMMING THE DOOR PANEL

**Managing the apartment list:**

Continued from previous page

(Step 6A) To assign a contact to a button on the EL632/GB2A module, click on the corresponding button in the module window, and a new window will be displayed. This enables the information relating to the indicated button to be edited.

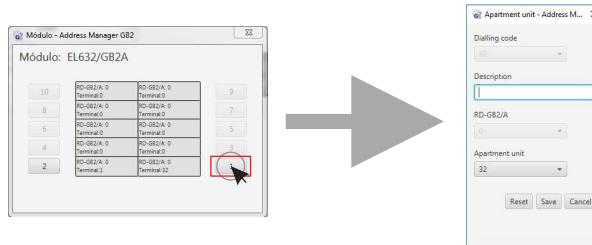

(Step 6B) To assign a contact to apartment list of the N3301/GB2 module, click on the 'Add' button located in the top left of the window, and a new window will be displayed. This enables the information relating to the new contact to be edited.

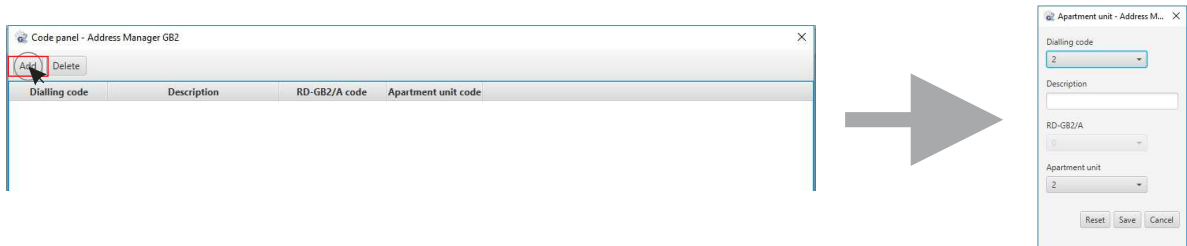

(Step 7) Then fill in the contact details, indicating:

- 'Dialling code': Code entered on the N3301/GB2 keypad to make the call.
- 'Description': Description of the apartment (ground floor 1, first floor 2, attic floor 3, etc.)
- 'RD-GB2/A' module number: Enter the code of the module in which the terminal (1-8) is located.
- 'Apartment unit' number: Enter the code that the terminal to be associated will have (1-32) or (1-128).

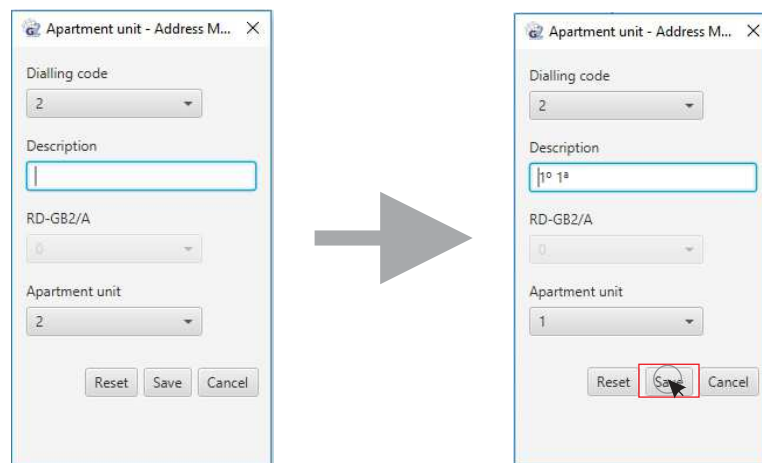

**IMPORTANT:**

- The 'Dialling code' can only be assigned if the previous step is '(Step 6B)', otherwise it will be configured with an assigned value that corresponds to the button code depending on the configuration selected for the EL632/GB2A module.A.
- The 'RD-GB2/A' module code can be changed if the door panel has been configured in 'Router' or 'Gateway' mode.

Finally, click on the 'Save' button to assign the changes to the indicated button or add the contact to the list.

**Continued overleaf**



PROGRAMMING THE DOOR PANEL

**Managing the apartment list:**

Continued from previous page

(Step 8) Once the apartment list entries has been edited, the list will be displayed. It can be edited by double clicking on the contact to change it if any detail is not correct.

Dialling code:	Description	RD-GB2/A code	Apartment unit code
11	1º 1ª	0	1
12	1º 2ª	0	2
13	1º 3ª	0	3
21	2º 1ª	0	4
22	2º 2ª	0	5
23	2º 3ª	0	6
31	3º 1ª	0	7
32	3º 2ª	0	8
33	3º 3ª	0	9

Finally, close the 'Code panel' window to display the 'Entry panel' window again.



(Step 9) From the 'Entry panel' window, it is possible to generate a configuration file containing the information that will be transferred to the EL632/GB2A module by means of the 'Save to SD card' button. It is also possible to generate a file containing the configuration of the DIP switches on the terminals and RD-GB2/A by means of the 'Create TXT configuration file' button.

Press the 'Save to SD card' button to save the information to the micro SD card. Select the root of the micro SD card from the folder manager displayed, click on the 'Save' button and a 'Namelist.bin' folder will be automatically generated with a 'Namelist.txt' file inside it, which will contain the information necessary to add the contacts list and configure the buttons if it has been modified.

**IMPORTANT:** For correct operation, DO NOT change the name of the 'Namelist.bin' folder or the 'Namelist.txt' file inside.

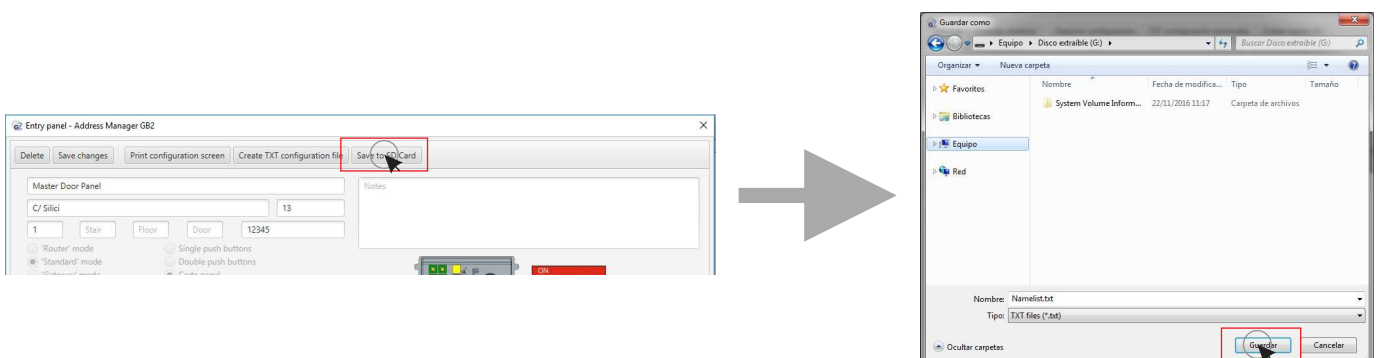

Continued overleaf

PROGRAMMING THE DOOR PANEL

**Managing the apartment list:**

Continued from previous page

**Transferring contacts list and configuring buttons on the EL632/GB2A module:**

(Step 1)  With DIP 6 of the EL632/GB2A module in the OFF position, disconnect the power supply of the EL632/GB2A module.

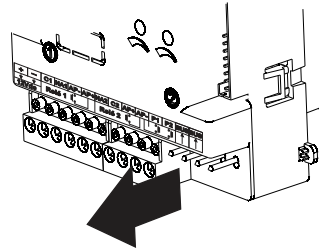

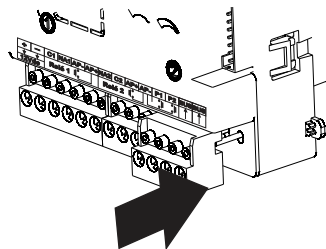

(Step 2)  Set DIP 6 of the EL632/GB2A module to ON.

(Step 3) Reconnect the power supply of the EL632/GB2A module.

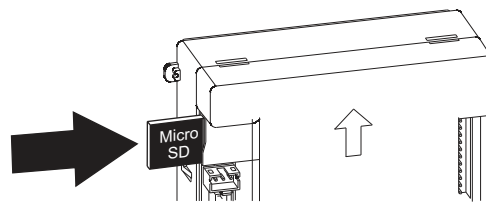

(Step 4) Once busy channel indicator  has been turned off, the user has 10 seconds to insert the micro SD card into the slot on the top left of the back of the EL632/GB2A module and press until it clicks.



(Step 5) Communication indicator  will illuminate and the door panel will beep to indicate that the information dump process has started.

(Step 6) When the process is complete, communication indicator  will turn off and the door panel will beep.

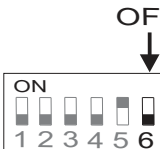
(Step 7)  Set DIP 6 of the EL632/GB2A module to the OFF position and remove the micro SD card by pressing it again.

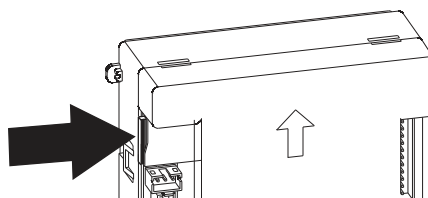

WIRING DIAGRAMS

**Video door entry system with 23 VESTA2 monitors, 12 D2L-GB2 distributors and Golmar DC lock release.**

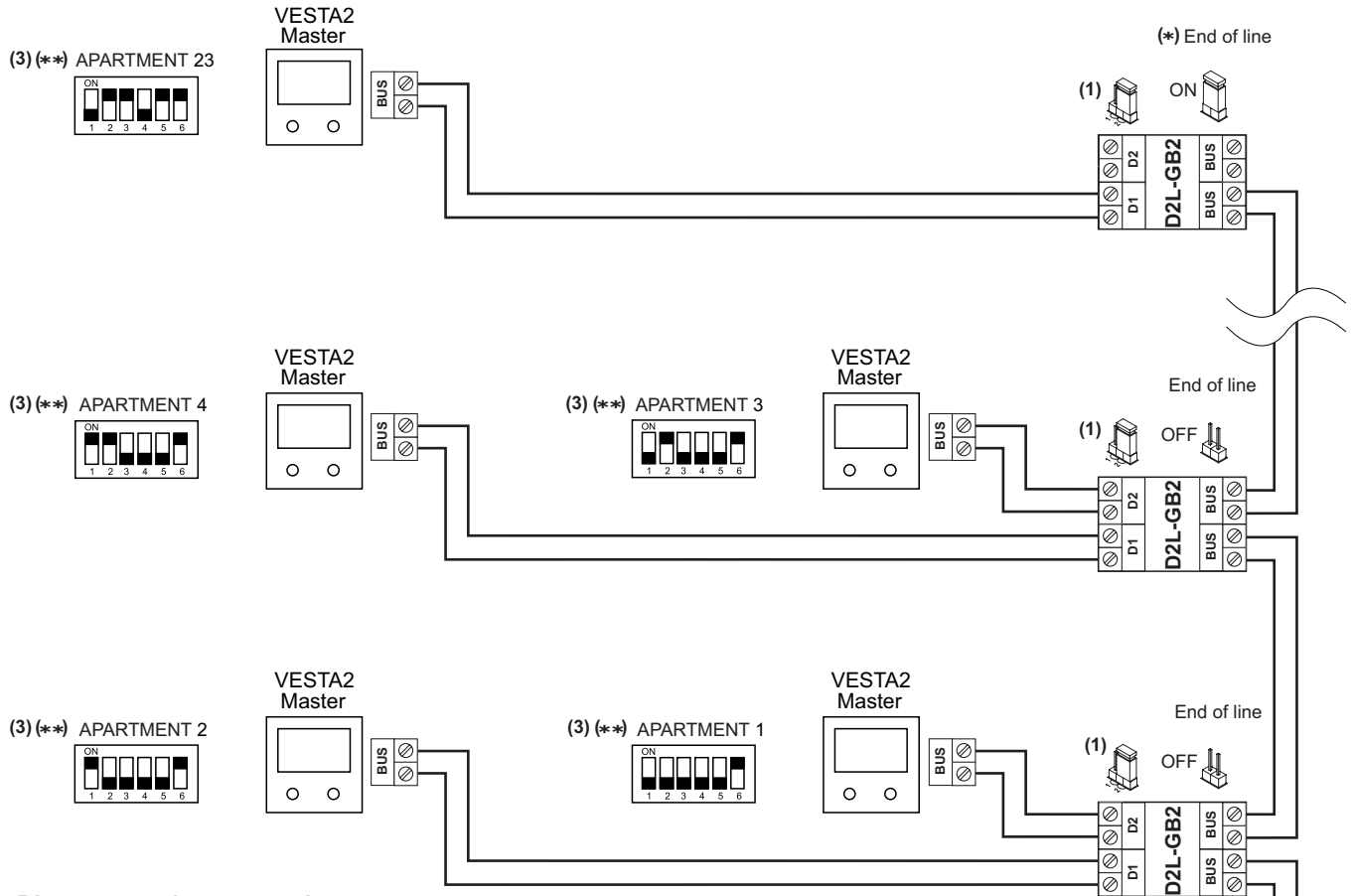

**Distances and cross-sections:**

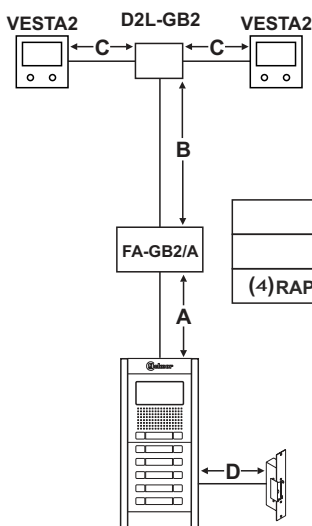

Cable	A	B	C	D
Twisted pair 2x0.75mm <sup>2</sup>	60m	60m	30m	10m
(4)RAP-2150 (twisted pair 2x1mm <sup>2</sup> )	80m	80m	40m	15m

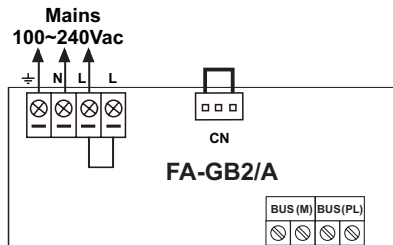

(1) Leave the jumper in this position for 4,3" GB2 monitors of all of the D2L-GB2 distributors.

(\*) Remove the jumper from all of the distributors except the last.

(\*\*) Configure the end of line in the last monitor. DIP 6 to ON.

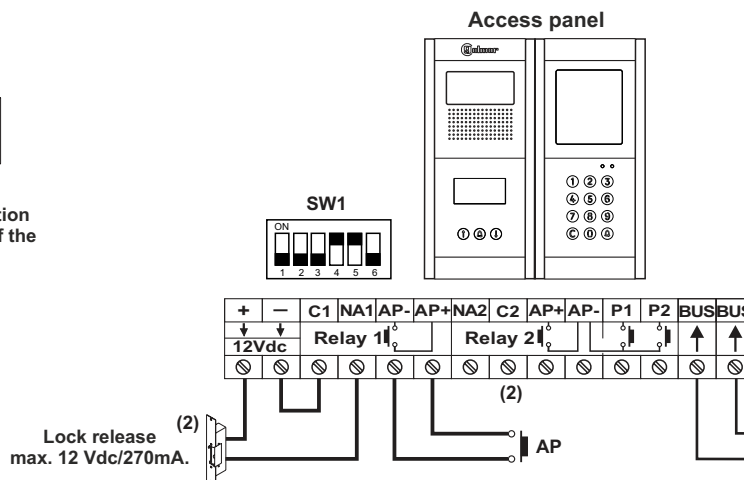

**Important:**

- (2) For the connection of an AC lock release or a 2nd lock release, see page 38.
- (3) For more information about the VESTA2 monitor, see the Quick Guide enclosed with its corresponding product.
- (4) Distances with Golmar RAP-2150 cable (twisted pair 2x1mm<sup>2</sup>).

WIRING DIAGRAMS

**Audio door entry system with 128 apartments/NHEA hands-free audio terminals and Golmar DC lock release:**  
 (The EL632 GB2A sound module should be set to 'operating mode 2 and 6' audio only, see pp. 7 and 8).

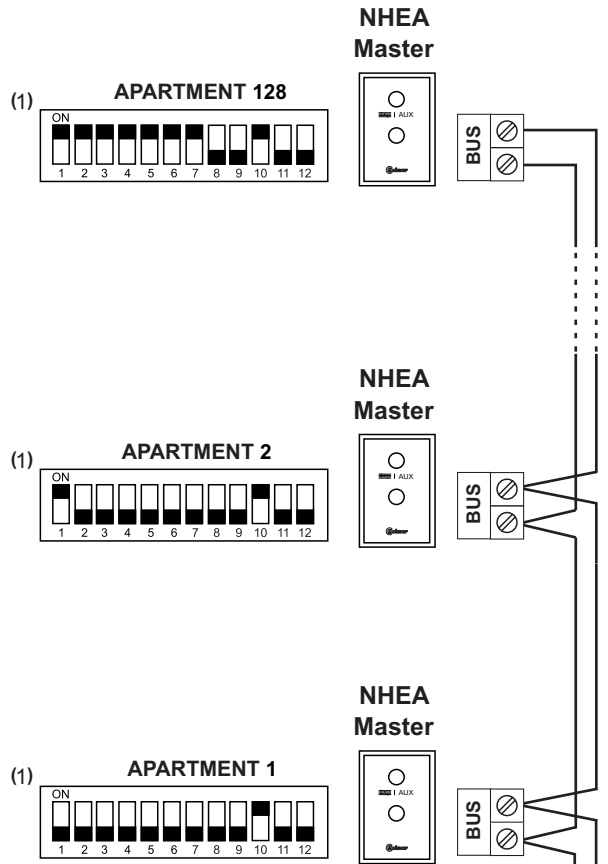

**IMPORTANT:**

- The TNHEA telephone's DIP 10 should be set to ON.

**Distances and cross-sections:**

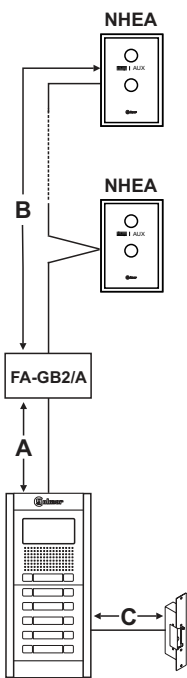

Cable	A	B	C
Twisted pair 2x0.75mm <sup>2</sup>	60m	60m	10m
(2)RAP-2150 (twisted pair 2x1mm <sup>2</sup> )	80m	80m	15m

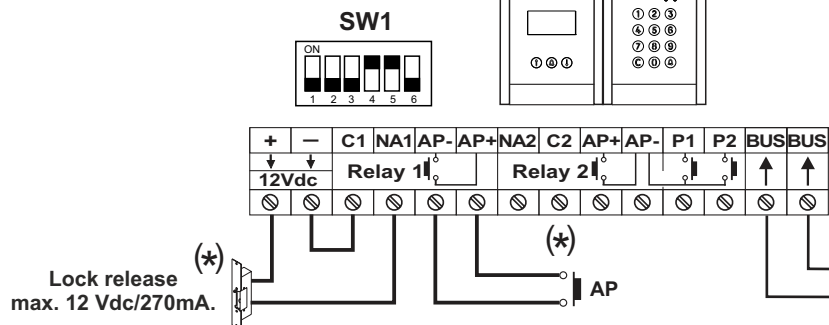
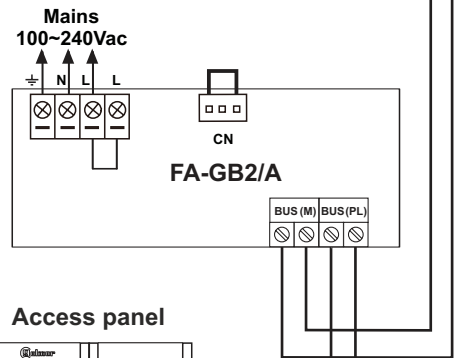

**Important:**

- (\*) For the connection of an AC lock release or a 2nd lock release, see page 38.
- (1) For more information about the NHEA hands-free audio terminal, see the Quick Guide enclosed with its corresponding product.
- (2) Distances with Golmar RAP-2150 cable (twisted pair 2x1mm<sup>2</sup>).

WIRING DIAGRAMS

Video door entry system with 4 access panels, DP-GB2A distributor for door panels and Golmar DC lock release.

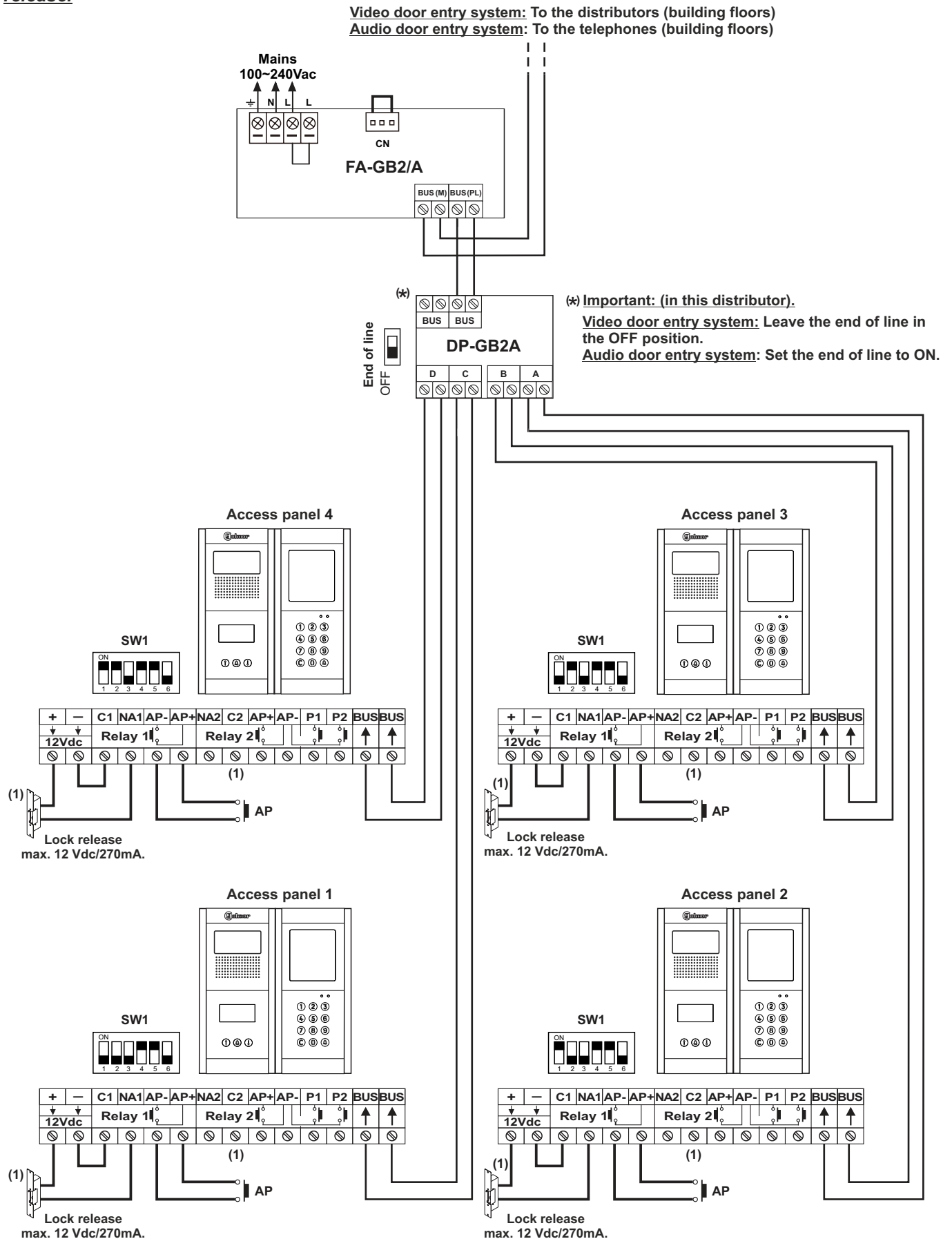

(1) Important: For the connection of an AC lock release or a 2nd lock release, see page 38.

WIRING DIAGRAMS

Connection of Golmar DC and AC lock releases.

Connection of 2 DC lock releases without 'AP':

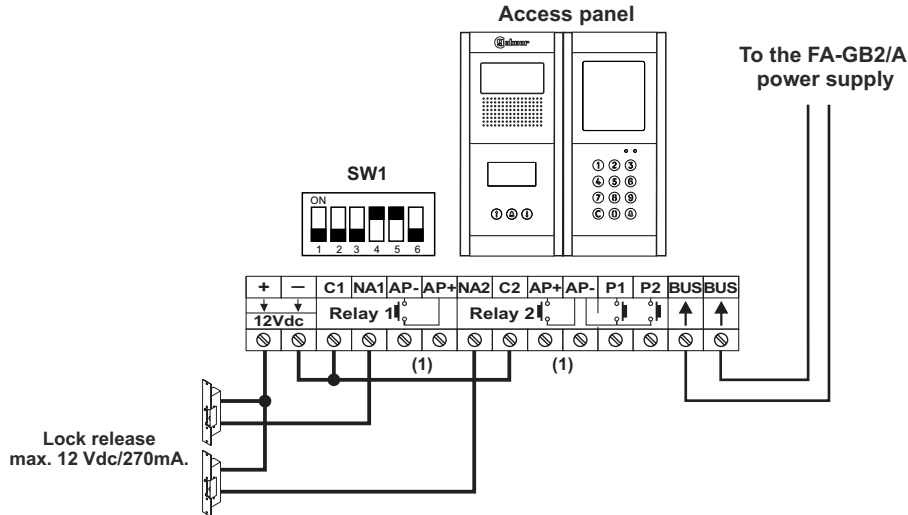

(1) Important: With 2 DC lock releases, it is not possible to use the "AP" door release buttons.

Connection of 1 AC lock release with 'AP':

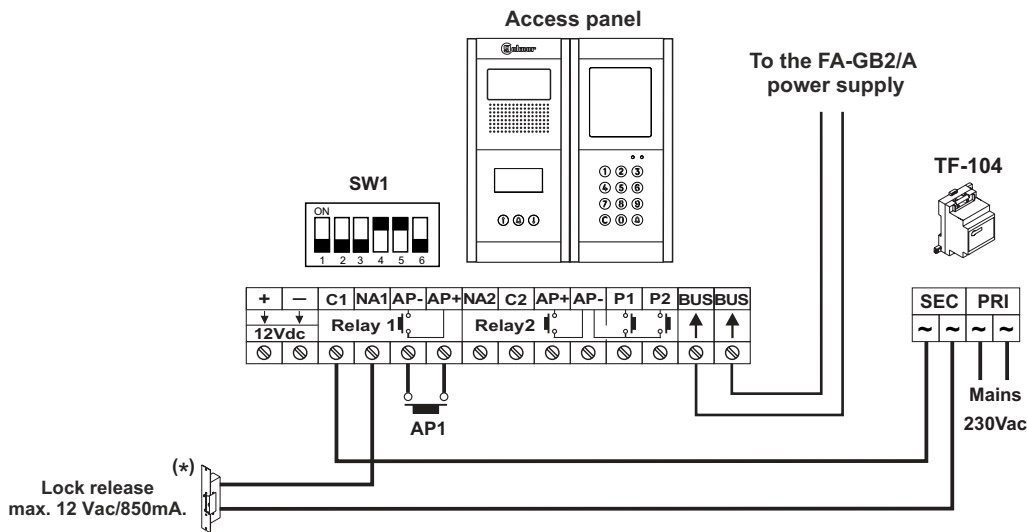

(\*) Important: Place the varistor supplied with the sound module directly onto the terminals of the lock release.

Connection of 2 AC lock release with 'AP':

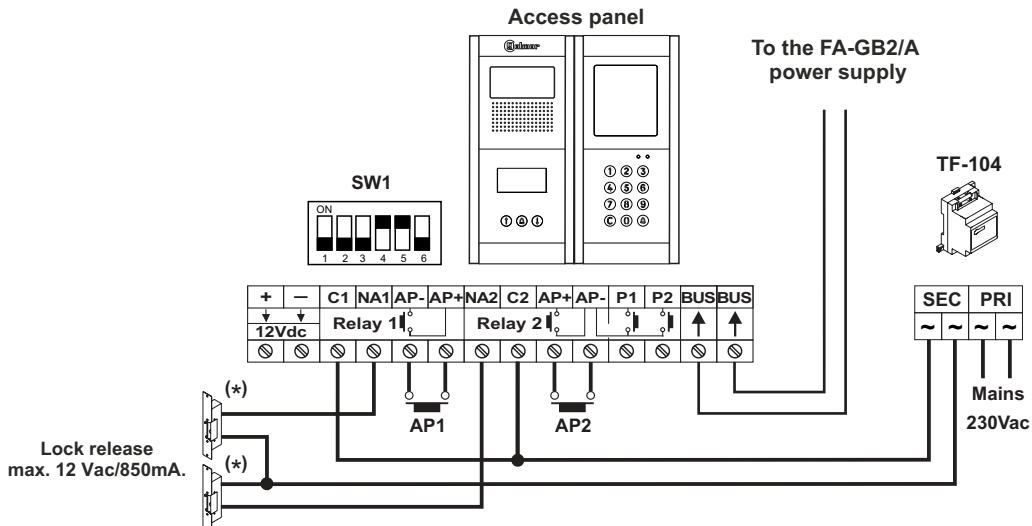

(\*) Important: Place the varistors supplied with the sound module directly onto the terminals of the lock release.

WIRING DIAGRAMS

Connection of the EL3002H/GB2 auditory accessibility module.

Connection of the EL3002H/GB2 module

If the door panel has an N3301/GB2 or NX3301/GB2 module, it will not be necessary to power the EL3002H/GB2 module with an additional TF-104, as shown in the following diagram.

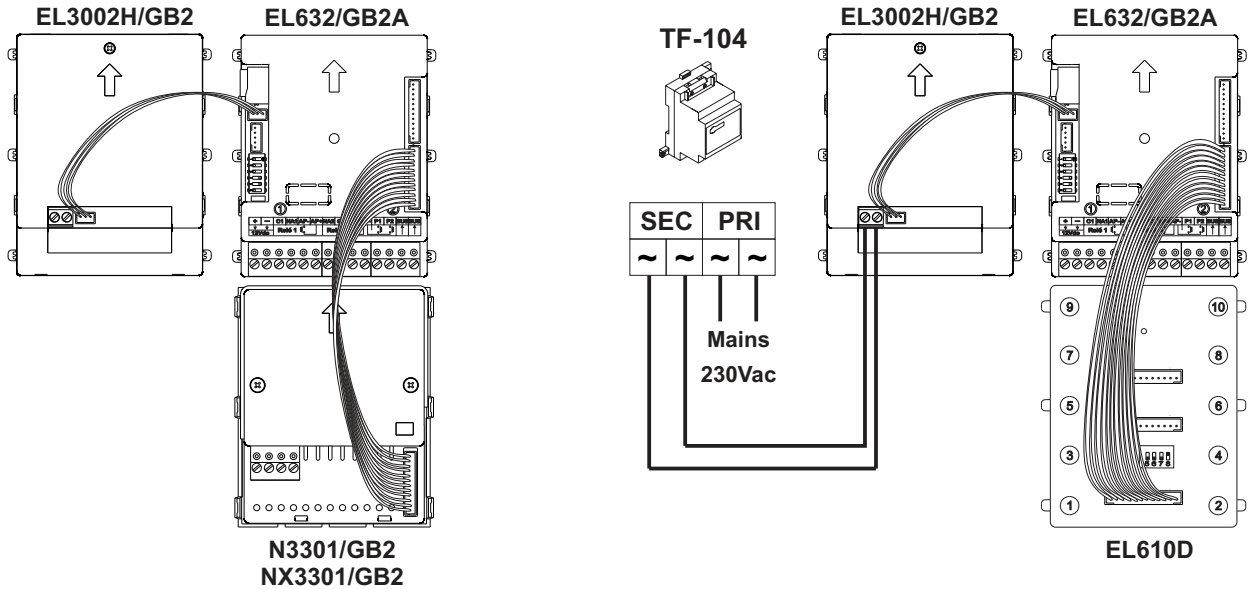

Connection if N3301/GB2 or NX3301/GB2 module exists

Connection if EL610D button module exists

Connection of the EL3002 illumination module.

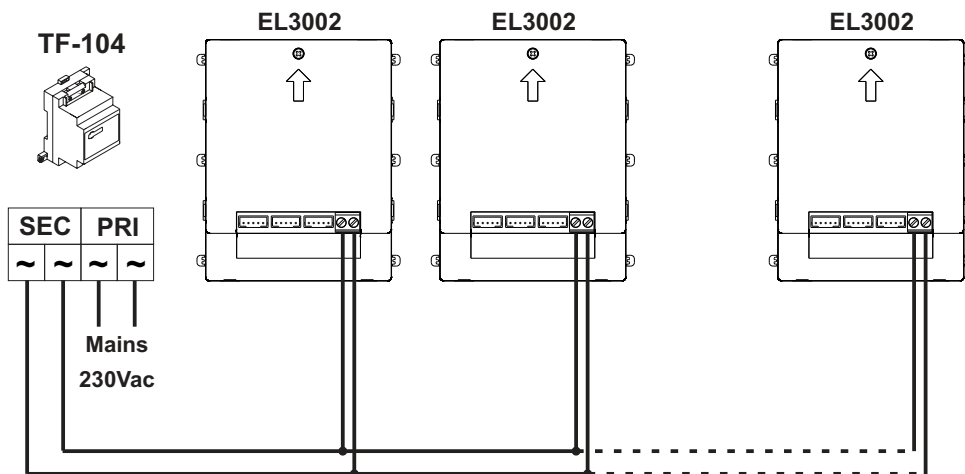





golmar@golmar.es  
www.golmar.es

GOLMAR S.A.  
C/ Silici, 13  
08940- Cornellá de Llobregat  
SPAIN



Golmar se reserva el derecho a cualquier modificación sin previo aviso.  
Golmar se réserve le droit de toute modification sans préavis.  
Golmar reserves the right to make any modifications without prior notice.